



**Tailor-made Wheelchair**



171000005000 <b>5700 €</b>	
17100000500? <b>5800 €</b>	

Fill in and send to Wolturnus - Udfyld og send til Wolturnus

Subject to Technical Modifications and Printing Errors / Technische Änderungen und Druckfehler vorbehalten  
Forbehold for tekniske ændringer og trykfejl

619000001009		
619000001109		
619000001209		
619000001309		
619000001409		
619000001509		
619000001609		
619000001709		
619000001809		
619000001909		
619000002009		
619000002109		
619000002509		
619000002609		
619000002809		
619000003309		
619000003409		
619000003509		
619000003609		
619000003009 <b>750 €</b>		
000000001102 <b>0 €</b>		

© Wolturnus A/S Merlin Winter 2024 V4.0

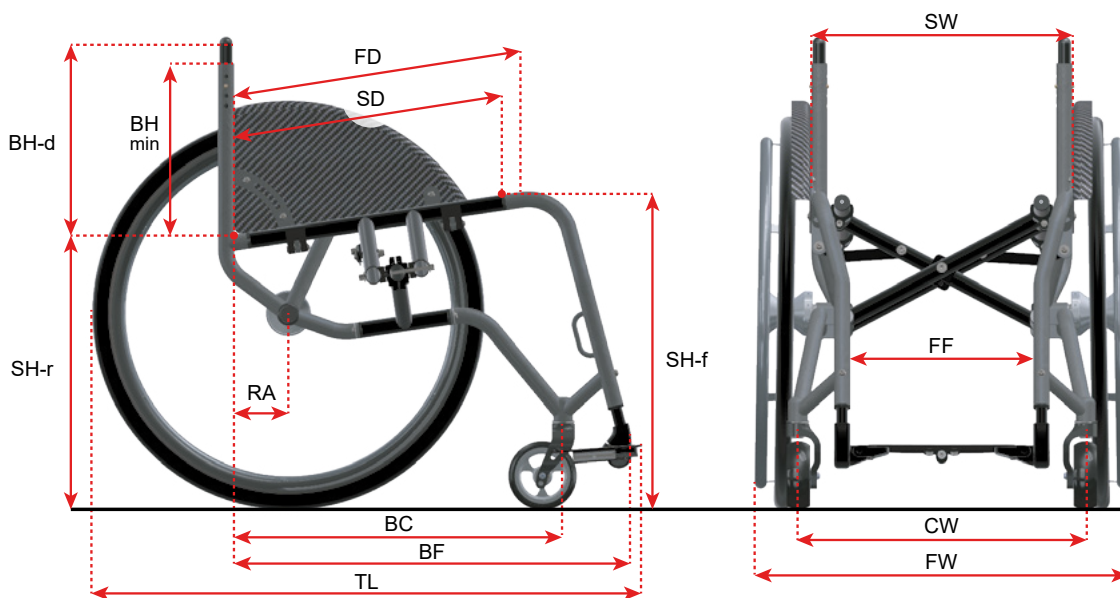

171000010??	!			<b>SW:</b> _____ cm
				<b>FD:</b> _____ cm
				<b>SD:</b> _____ cm
				<b>SH-r</b> _____ cm
				<b>SH-f:</b> _____ cm
				<b>C:</b> _____ °
				<b>BH:</b> _____ cm
				<b>BH-d:</b> _____ cm
	!			<b>BH-max:</b> _____ cm
				<b>BH-min:</b> _____ cm
				<b>RA:</b> _____ cm
				<b>BF:</b> _____ cm
				<b>BC:</b> _____ cm
				<b>CW:</b> _____ cm
				<b>TW:</b> _____ cm

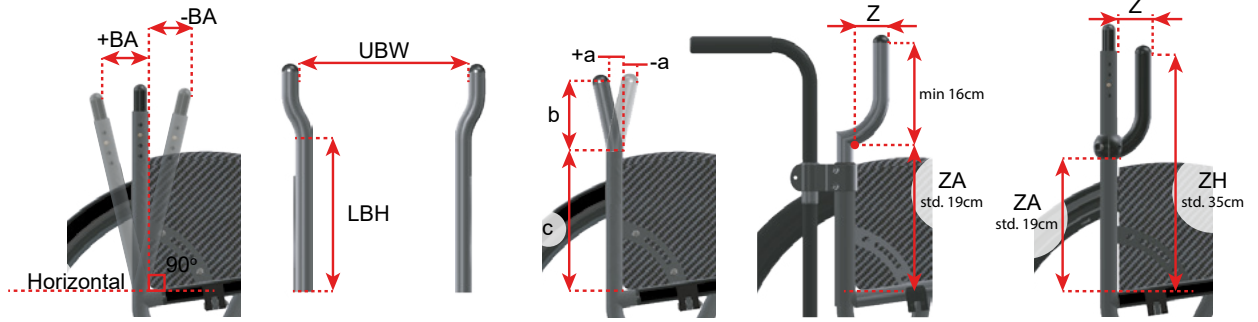

				BA: _____ ±cm	
812200200002 <b>246 €</b>				UBW: _____ cm	
812200200001 <b>246 €</b>				LBH: _____ cm	
812200200020 <b>147 €</b>				a: _____ cm	
				b: _____ cm	
				c: _____ cm	
8122002001?? <b>560 €</b>	!			_____ cm	
8122002001?? <b>723 €</b>					
82501000???? <b>560 €</b>					
8122002001?? <b>930 €</b>					ZA: _____ cm
8122002001?? <b>930 €</b>					Z: _____ cm
				ZH: _____ cm	
8861101013?? <b>325 €</b>					
8861101013?? <b>325 €</b>					
				AF: _____ cm	
				AW: _____ cm	



--	--

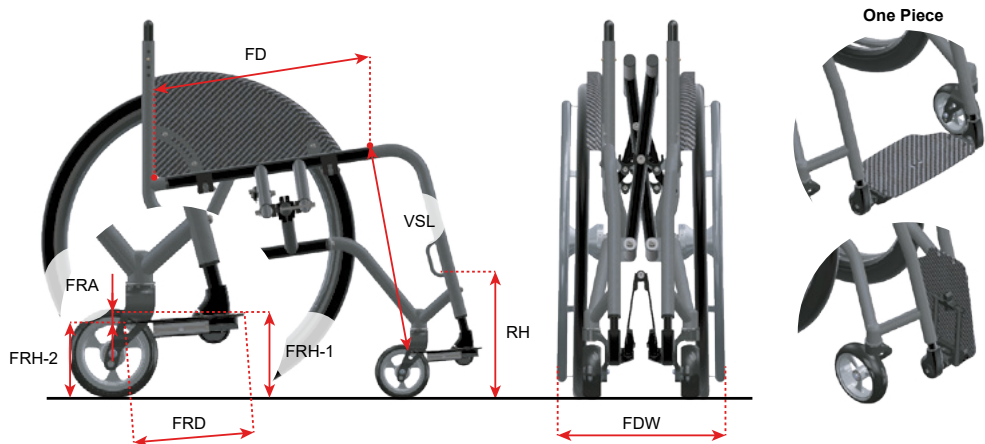



			VSL/USL: _____ cm
			FRH-1: _____ cm
			FRH-2: _____ cm
			-1,5   -3 +1,5   +3
			FRA: _____ cm
8350??010001 <b>0 €</b>			
8350??020001 <b>0 €</b>			
8350??030001 <b>0 €</b>			
8350??030001 <b>0 €</b>			
8350??050001 <b>461 €</b>		FF 22cm FF 24cm FF 26cm FF 28cm FF 30cm FF 32cm FF 34cm	
8350??060001 <b>711 €</b>		FF 22cm FF 24cm FF 26cm FF 28cm FF 30cm FF 32cm FF 34cm FF 36cm FF 38cm FF 40cm	
835099210001 <b>68 €</b>			
691000010001 <b>68 €</b>			RH: _____ cm

Fill in and send to Wolturnus - Ausfüllen und an Wolturnus senden - Udfyld og send til Wolturnus

Subject to Technical Modifications and Printing Errors / Technische Änderungen und Druckfehler vorbehalten  
Forbehold for tekniske ændringer og trykfejl

© Wolturnus A/S Merlin Winter 2024 V4.0

				1+	2+	3+	4+	5+
761000000010 <b>245 €</b>								
710000000001 <b>0 €</b>								
710099990010 <b>440 €</b>								
710099990012 <b>470 €</b>								
710099990013 <b>470 €</b>								
710099990011 <b>470 €</b>								
710099990001 <b>0 €</b>								
710099990003 <b>185 €</b>								
710099990004 <b>185 €</b>								
710099990002 <b>185 €</b>								
710099990000 <b>0 €</b>								
750000009000 <b>265 €</b>			!	_____ cm / _____ cm				
- <b>0 €</b>		!			5cm Std.	7cm		
750000000005 <b>68 €</b>					Medium Std.	Hard		

				
881000100003 <b>0 €</b>				
881000600003 <b>0 €</b>				
881000?0000 <b>340 €</b>				
88100010000? <b>0 €</b>				
88100040000? <b>300 €</b>				
8810005000?? <b>744 €</b>				
88100020000? <b>725 €</b>				
8810003000?? <b>800 €</b>				

883124101014 <b>240 €</b>			
681000010002 <b>70 €</b>			
681000010052 <b>70 €</b>			
7670000000?? <b>170 €</b>			

		<b>GH:</b>	_____ cm
		<b>GL:</b>	_____ cm
		<b>MC:</b>	_____ cm

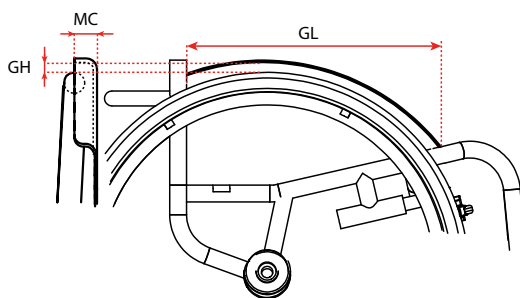



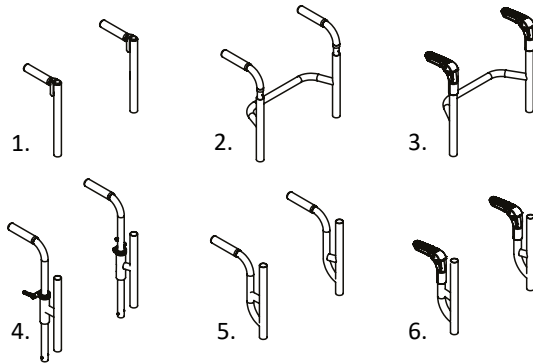

--	--









81310005?106 <b>330 €</b>		1.		
81310005?206 <b>367 €</b>				
81310005?108 <b>330 €</b>		2.		
81310005?208 <b>367 €</b>				
81310005?107 <b>183 €</b>	3.			
81310005?207 <b>230 €</b>				
81310005??02 <b>524 €</b>		4.		
81310005??04 <b>367 €</b>		5.		
81310005??05 <b>576 €</b>		6.		
				PH: _____ cm

69100002002? <b>275 €</b>			
886210101001 <b>340 €</b>			
7600000100?? <b>68 €</b>			
76100000000? <b>162 €</b> <b>225 €</b>			
7711000007?? <b>110 €</b> <b>110 €</b> <b>110 €</b>			 
771100000747 <b>110 €</b>			
953001040120 <b>110 €</b>			

--	--

885110101101 <b>199 €</b>			
885110111101 <b>199 €</b>			
885110201209 <b>225 €</b>			
885110201300 <b>250 €</b>			

951500020019 <b>70 €</b>			
-----------------------------	--	--	--

966401253410 966401003410		<b>178 €</b> <b>178 €</b>	
------------------------------	--	------------------------------	---

966401253400 966401003400 966401003403 966401003402 966401003401 966401003404		<b>0 €</b> <b>0 €</b> <b>0 €</b> <b>0 €</b> <b>0 €</b> <b>0 €</b>	
--	--	--	--



966401250120 966401250220 966401250320 966401250020		<b>325 €</b> <b>325 €</b> <b>325 €</b> <b>325 €</b>	
966401000120 966401000220 966401000320 966401000020		<b>325 €</b> <b>325 €</b> <b>325 €</b> <b>325 €</b>	
966401250?20 966401250620 966401250520 966401250420		<b>377 €</b> <b>377 €</b> <b>377 €</b> <b>377 €</b>	
966401000?20 966401000620 966401000520 966401000420		<b>377 €</b> <b>377 €</b> <b>377 €</b> <b>377 €</b>	

9521000000?		<b>0 €</b>	
		<b>0 €</b>	

--	--	--	--

	22"	24"	25"	26"	
85102??01009					0 €
85102?10100?	-			-	0 €
8510??101002				-	257 €
851124201009	-		-	-	471 €

	22"	24"	25"	26"		
85352?101008					895 €	
85352?101208					895 €	
85352?101508	-				895 €	
85352?101308					895 €	
85352?102108					895 €	
85352?101009					695 €	
85352?101209					695 €	
85352?101509	-				695 €	
85352?101309					695 €	
85352?101?09					695 €	

85352?101608					950 €	
85352?101408	-			-	950 €	
85352?101808					950 €	
85352?101708					950 €	
85362?241008					950 €	
85362?241208	-				950 €	
85362?241508					950 €	
85362?241308					950 €	
85362?181008					950 €	
85362?181208	-				950 €	
85362?181508					950 €	
85362?181308					950 €	

--	--

	22"	24"	25"	26"	
96622?010001				-	0 €
96622?01000?					68 €
96622?010009					146 €
96622?010021	-				146 €
966224010013	-		-	-	68 €
96622?011008	-		-	-	68 €
966224010007	-				68 €

85512?10200?					0 €
85512?102008	-			-	194 €
85502?103009	-				178 €
85552?000009					503 € 629 €
8554202?0601					315 €
8554262?0601	-				575 €
8554272?0601	-				575 €
8554282?0601					700 €
9669282?0602					700 €
8554302?0601					700 €
8554502?060?	-			-	700 €
8554502?060?	-			-	700 €

				!	
--	--	--	--	---	--

85712?102009					178 €
--------------	--	--	--	--	-------

--	--	--	--	--	--

000000001104 100 €					
-----------------------	--	--	--	--	--

EN ISO 14971

--	--	--	--	--	--

P.4	
P.5	
P.6	
P.8	
P.9	
P.10	
P.11	
P.12	





