



SERVICE MANUAL

ENGLISH



SERVICE MANUAL

EXELLE - EXELLE VARIO

Rev. 1 - 2021/05



progeo
ACTIVE DESIGN



SERVICE MANUAL

EXELLE - EXELLE VARIO

GENERAL WARNINGS

ANY ADJUSTMENT CAN BE CARRIED OUT EXCLUSIVELY BY QUALIFIED AND AUTHORIZED BY REHATEAM S.R.L. PERSONNEL.

It is forbidden to carry out any modifications, even when possible, to the original design.

Any adjustments and/or any modification that is carried out by non-authorized personnel will immediately void the warranty on the product and it relieves Rehateam s.r.l. from any responsibility on any malfunctioning and/or damage due to such adjustments/modifications.

Always contact Rehateam s.r.l. and its technicians for any non-standard requirements or modifications to allow them to evaluate such modifications and verify that they will not compromise the normal and safe use of the wheelchair.

Any modification of the original parameters and set up could seriously compromise the safe operation of the wheelchair causing damage to both the user and the wheelchair itself.

After every adjustment made to the wheelchair, check carefully that all parts are correctly fixed. Check that all screws and nuts are tightened and that all moving parts are functioning correctly.

After any adjustment, always test the wheelchair before giving the product to user and/or his/her attendant.

Rehateam s.r.l. disclaims any responsibility for damage to the product, to any object or to people due to any modification that is not properly performed or that, in any case, does not guarantee safety to the user.



SERVICE MANUAL

EXELLE - EXELLE VARIO

Page	adjustment
04	FRONT HEIGHT 1 Caster on fork
05	FRONT HEIGHT 2 Standard fork and axle
06	FRONT HEIGHT 3 Support for fork with integrated bearings
07	FORK SUPPORT POSITION Standard fork support; support for fork with integrated bearings
08	FORK ANGLE 1 System with hexagon
09	FORK ANGLE 2 System with 4 grab screws
10	DIRECTIONALITY
12	REAR HEIGHT Standard rear frame
13	REAR HEIGHT AND SETTING Dynamic rear frame (first version)
16	REAR HEIGHT Dynamic 2.0 rear frame
17	SETTING (point of balance) Standard rear frame
18	SETTING (point of balance) Dynamic 2.0 rear frame
19	SIDE GUARD Standard rear frame - Dynamic 2.0 rear frame
21	SIDE GUARD Dynamic rear frame (first version)
24	SIDE GUARD Removable with blade system
26	CAMBER Standard rear frame
27	CAMBER AND CONVERGENCY Dynamic rear frame (first version) and Dynamic 2.0
29	BRAKE WITH PLATE OF SUPPORT
31	BRAKE WITH CLAMP
32	BRAKE SPACING
33	FOOTPLATE DISTANCE
34	DOUBLE FOOTPLATE
35	ONE PIECE FLIP-UP PLASTIC FOOTPLATE
37	ONE PIECE FLIP-UP ALUMINUM FOOTPLATE
39	ONE PIECE FLIP-UP CARBON FOOTPLATE
41	ONE PIECE PLASTIC FOOTPLATE WITH AUTOMATIC CLOSURE
43	ONE PIECE ALUMINIUM FOOTPLATE WITH AUTOMATIC CLOSURE (COMPACT)
44	BACKREST HEIGHT Standard rear frame
45	BACKREST HEIGHT Dynamic rear frame (first version) and Dynamic 2.0
46	BACKREST ANGLE Dynamic rear frame (first version) and Dynamic 2.0
47	QUICK RELEASE AXLE (rear wheel)
48	SEAT WIDTH ENLARGEMENT Standard and Dynamic 2.0 rear frame
50	FOOTPLATE FRAME LOCKING POSITION (only Exelle Vario)



SERVICE MANUAL

FRONT HEIGHT 1

(caster on fork)

Standard version



Holes interval – 12,7 mm

- Sport** – 2 holes – h. 88
- Small** – 3 holes – h. 112
- Medium** – 5 holes – h. 152
- Long** – 4 holes – h. 178

Version with integrated bearings



Holes intervals – 12,7 mm

- Sport** – 2 holes – h. 100
- Small** – 3 holes – h. 115
- Intermediate** – 4 holes – h. 145
- Medium** – 5 holes – h. 170

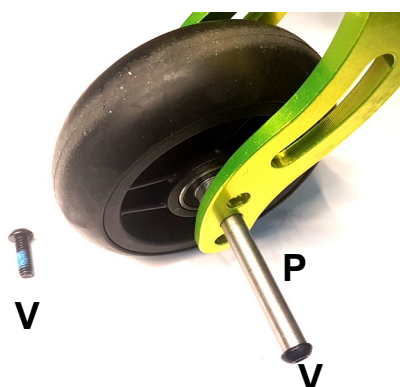

The entity of the adjustment obviously depends on the caster and fork's sizes.

Screw off the bolt **V** while holding the other.

Remove the axle **P**.

Position the caster to another hole, insert the axle and fix the bolt **V** holding the one on the other side.

Pay attention to the spacers between caster and fork.



It is advisable to spread a drop of mild lock thread glue on the bolts **V**.



SERVICE MANUAL

FRONT HEIGHT ADJUSTMENT 2

(standard fork and axle)

Only for forks with \varnothing 12 axle hole, it is possible to change the axle **P** with a longer one (usually 25mm longer).

To replace the fork axle, first you need to remove the fork from its support.

Remove the cap and, with a 19 mm tubular box spanner while holding the fork with one hand, screw off the locknut **B**.

Now, hold the axle in its point **A** (16 mm spanner), screw off the locknut **D** and remove the axle.

Insert the new axle and firmly tighten it on the fork.

Similarly, you can change the fork with another of different size.

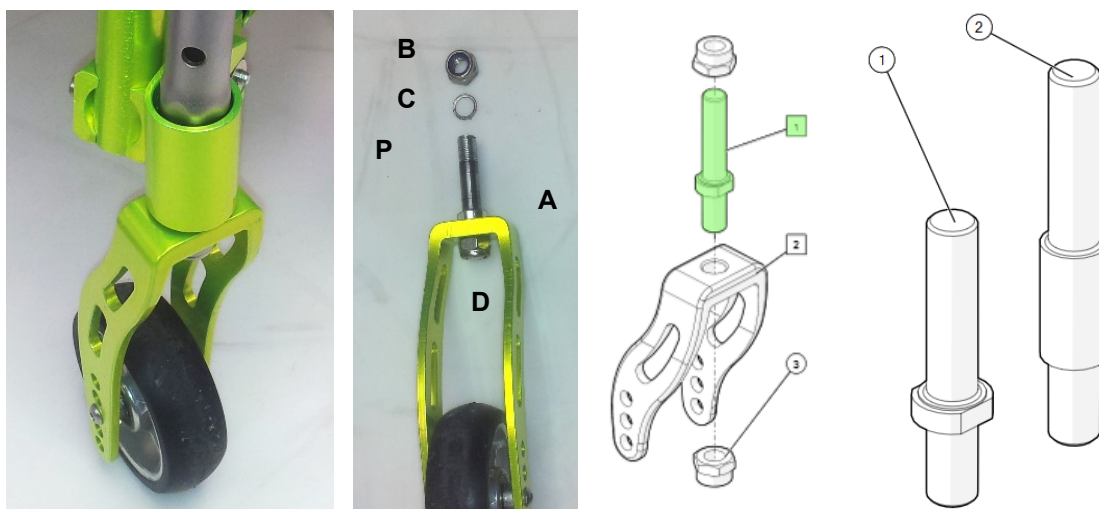

To get access to the nut **D**, it may be necessary to remove the wheel.

If the locknut **D** is too hard to unscrew, warm it with a hot air blower.

When assembling the fork on the support, put the washer **C** and then the locknut **B**. screw the locknut **B** holding the fork. The correct torque has to zero the vertical play while letting the fork smoothly swivel.

Remember that the front height adjustment can affect the seat inclination, so it is necessary to check and adjust the fork angle



SERVICE MANUAL

FRONT HEIGHT 3

(support for forks with integrated bearings)

It is possible to change the fork support.

In fact, there are two sizes for this support: short and long. The difference between the two is 3 cm.



To remove the support, unscrew the two bolts **A**.

Insert the new support and fix it with the two bolts **A**.

The model Exelle also has the spacer **B** between support and frame, and two cylindrical spacers **C**.

Make sure to put back these two elements correctly.

Le due boccole cilindriche **C** devono essere sempre presenti nei fori di fissaggio del supporto.



Note: if you wish to keep the same fork, it is obviously necessary to take it off from the just removed support.



It is advisable to spread a drop of mild lock thread glue on the bolts **V**.



FORK SUPPORT POSITION

standard fork support—support for fork with integrated bearings

In particular cases, it is possible to move the fork support.

Such operation becomes necessary if the front wheel touches the footplate.

EXELLE: the frame has 5 holes for support positioning, therefore, 3 possible positions.

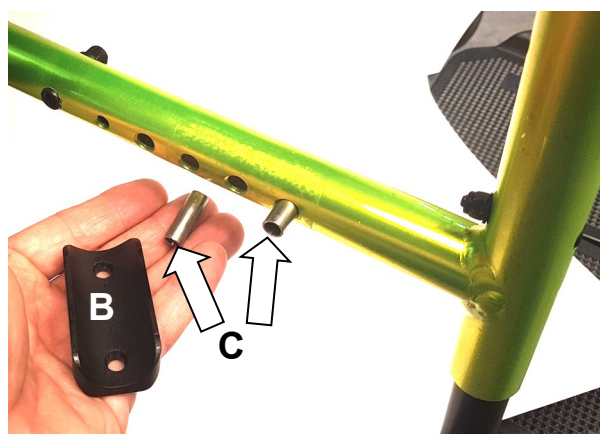
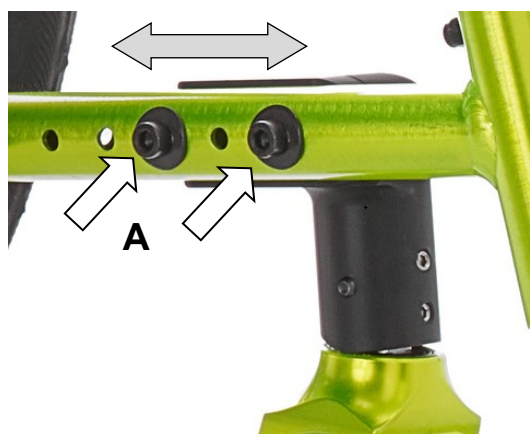

To remove the support, screw off the two bolts **A**.

Remove the spacer **B** between support and frame, and the two cylindrical spacers **C**.

Insert the two cylindrical spacers **C** in two other positioning holes.

The two cylindrical spacers **C** must always be present in the support fixing holes.

Position the spacer **B** and fix the support with the two bolts **A**.

EXELLE VARIO : the frame has 4 holes for support positioning, therefore, 2 possible positions.

Screw off the two bolts **A**.

Fix the support to the other position.



Warning: if you fix the support in the rearward position, it is vital to use another bolt and nut to fix the frame junction. That bolt has to be of the type “countersink” and, consequently, you will have to make a proper housing on the corresponding hole.



It is advisable to spread a drop of mild lock thread glue on the bolts **A**.



FORK ANGLE 1

system with hexagon

SERVICE MANUAL

WORK ON A FLAT AND EVEN SURFACE.

The adjustment is the same for both Exelle and Exelle Vario. The pictures show the assembly on the Exelle Vario.

Unscrew the bolt **V** that fixes the nut **D**.

Remove the nut **D** but leave the bolt on completely. You should not loosen the other bolt, in fact it will hold the fork while performing the adjustment.

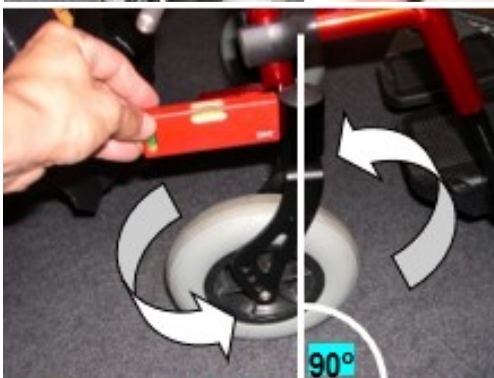
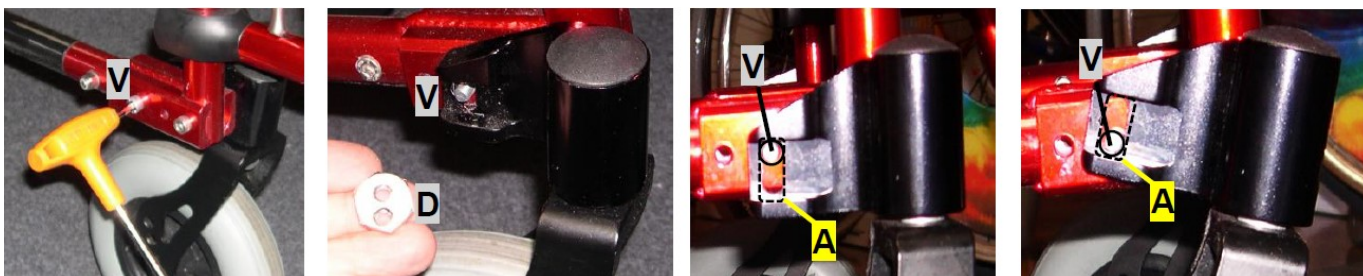

You can now turn the fork support (and the fork itself) clock or anti clock wise within the limits given by the support's slot **A** against the bolt **V**. Within such limits you will have to find the correct angle: the fork has to be perpendicular to the ground.

You can reveal the perpendicularity using a spirit level leant against the cylinder of the fork support as shown in the picture, or you can turn the fork. In this last way, the caster should evenly touch the ground all around the clock.

When you find the correct angle, you have to insert the nut **D** with two of its two sides perfectly aligned with those of the slot **A**, but without moving the fork support.

The adjustment nut **D** has two holes. Each hole gives 6 different positions, so, in total there are 12 positions.



Insert the nut on the bolt using one hole and turn it to try the 6 positions. You cannot position the nut if the bolt is touching either side of the slot.

When you find the coinciding position, push the nut into the housing and tighten the bolt. Should no position allow for the perfect alignment, try the other hole of the nut and repeat the same operations.

DO NOT adapt the position of the fork support to the nut, this way you actually change the fork angle.

If you cannot reach the perpendicularity within the range given by the slot **A**, remove the bolt **V1** and remove the fork paying attention to which of the two holes **A** or **B** it was fixed to.

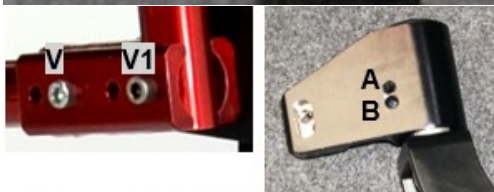

Assemble the fork using the other hole and tighten the corresponding bolt.

Repeating the same operations above mentioned, adjust the fork angle and position the nut.

Finally, tighten the bolts **A** and **B** hard.

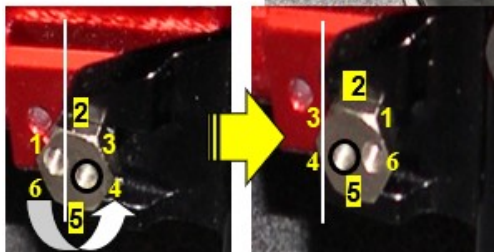

If, in the coinciding position, the nut is leaning out of the support, it is advisable, in order to have a better hold, to reverse its position (of course, using the same hole); this way, the nut will fully be located within the support housing.



It is advisable to spread a drop of mild lock thread glue on the bolts **V** and **V1**.



FORK ANGLE 2

System with 4 grab screws

SERVICE MANUAL

WORK ON A FLAT AND EVEN SURFACE

Whenever the seat height is changed or as periodic maintenance, check the fork angle and, if necessary, adjust it in order to have the fork axis perpendicular to the ground. Exelle and Exelle Vario uses the same system (the pictures show the model Exelle).

The adjustment is possible by means of the four grab screws **G1**, **G2** and **G3** that make the axle **P** turn on the fulcrum **F**.

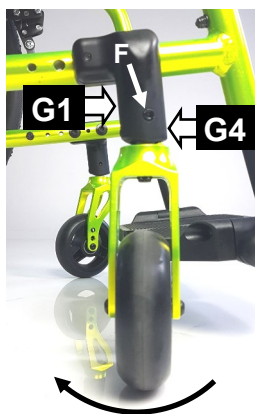
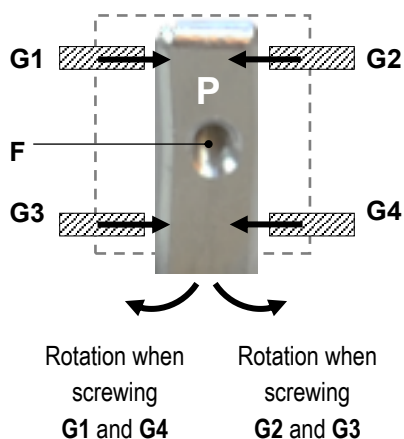

To turn the fork backward

Loosen **G2** and **G3**.

Screw **G1** and **G4**

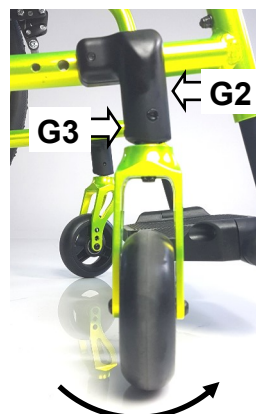

To turn the fork forward

Loosen **G1** and **G4**.

Screw **G2** and **G3**



Perpendicularity

You can check the perpendicularity with the help of a square (or similar) vertically aligned to the caster turned 90° with respect to the driving direction of the wheelchair

To adjust the fork, once you know the direction (forward or backward) towards which it is necessary to move the fork's axle, proceed as above-mentioned until reaching the correct angle.

You can also measure the perpendicularity by turning the fork by 360°: during the full turn, the wheel has to touch the surface in all positions.



If a headless bolt results hard to unscrew, DO NOT FORCE IT, but try to loosen the other two first.

If the fork's axle (the axle **P**) results hard to move, slightly loosen the bolt of the fulcrum **F** (remember to screw it after adjustment).

Once you reach the correct angle, screw all three headless bolts all the way down to the axle **P**, but without tightening.

In order to fix the system, tighten first one and then the other less than a quarter of a turn at once, the grab screws **G2** and **G4** (the front ones) checking the perpendicularity; in fact, it may slightly change during this phase.

Should that happen, correct the angle proceeding in the same manner.

When you have tightened both headless bolts **G2** and **G4**, you can tighten the headless bolt **G1** and **G3**.

Check the perpendicularity again and, if necessary, correct it.

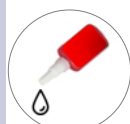

It is advisable to pread a drop of mild lock thread glue on all grab screws **G**.



DIRECTIONALITY

SERVICE MANUAL

A very important aspect of any wheelchair is its directionality.

To check if the wheelchair goes straight, sit on it, push it and let it go until it stops.

If something is wrong, the slower the wheelchairs moves forward (momentum close to nothing), the more likely it turns right or left. Therefore, if no or irrelevant turn occurs, the wheelchair is properly adjusted.

Cause	Reason	Solution
SURFACE	The surface where the test is being performed is not even and flat	Test the chair on even and flat surface
REAR WHEELS	The rear wheel are not equally inflated	Inflate both tyres at the same pressure
	The tyres of the two rear wheel are different or differently	Change the tyres
	The rear wheels are not adjusted at the same height	Adjust the rear wheel height
	The camber of right and left wheels are different or differently adjusted	Adjust the camber.
	The wheel, when turning, touches the side guard or the brakes	Fix or replace the side guard. Add spacer on the receiver. Adjust the brake.
	The wheels do not turn smoothly	Clean or change the bearings
FRONT WHEELS	The casters are not adjusted at the same height	Adjust the front wheels at the same height
	The tyres of the two front wheels are different or differently	Change the wheels
	The fixing bolts of the fork/fork support/clamp are loosened	Check and tighten all fixing bolts
	The caster does not turn smoothly	Clean the bearings.
	Either or both forks are not adjusted so as their axis is perpendicular to the ground.	Adjust the fork axis inclination.
FOOTPLATE	The footplate tubes are adjusted at different height.	Adjust the tubes at the same height

If the wheelchairs does not go straight, in most cases the reason is the fork angle adjustment.

However, before working on the fork angle adjustment, check all the points above mentioned.

First, make the test along a flat even surface to check the directionality.

1 The correct adjustment has both forks perpendicular to the ground, that is, their axis at 90°.

2 If the wheelchair **TURN RIGHT**, the cause is one or more of the following:

The **RIGHT** fork is tilted **inwardly** and/or **backward**

The **LEFT** fork is tilted **outwardly** and/or **frontward**

3 If the wheelchair **TURN LEFTT**, the cause is one or more of the following:

The **LEFT** fork is tilted **inwardly** and/or **backward**

The **RIGHT** fork is tilted **outwardly** and/or **frontward**

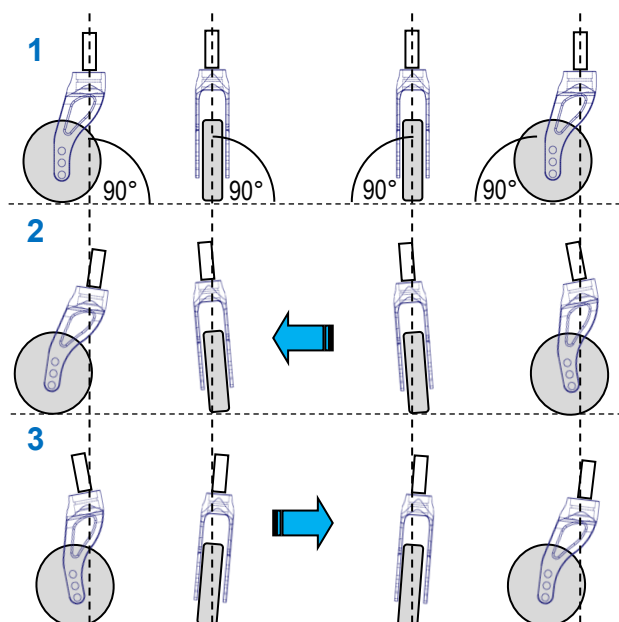

Follows next page



DIRECTIONALITY

SERVICE MANUAL

Adjusting the directionality

Check that the two forks are perpendicular to the ground. If they are not, proceed with the adjustment of the fork angle following the instructions on the sheet FORK ANGLE ADJUSTMENT.

If both forks axis are correct but the wheelchair still turns right or left, it means that the latitudinal angle is not perfect.

This may be due to hit, to improper pressure exercised on the fork or its support, or to a tiny imperfection among all parts fixed together due to their manufacturing tolerances.

Since both angle adjustment systems do not allow for latitudinal (camber) adjustment, the only way to correct the angle is to put a sort of spacer between the upper or lower side of the fork support and the plate where it is fixed. The spacer can simply be a piece of plastic strapping (0.5 mm – 1 mm thick).

To incline the fork internally **1**, position the strapping on the upper side of the fork support.

To incline the fork externally **2**, position the strapping on the lower side of the fork support.



Plastic strapping



For the adjustment of the fork angle and the removal of the fork support, see chapters “fork angle” and “fork support position”



REAR HEIGHT

Standard rear frame

SERVICE MANUAL

Adjustment every 1.5 cm

You can adjust the rear height by moving the rear wheel plate **A** with respect to the frame **B**.

Remove the 4 bolts **C** and nuts **D** and remove the plate **A**.

Position the plate **A** at a different height and fix it using the pre-drilled holes on the frame.

If case of titanium frame, the assembly has an extra counter plate **E** on each side of the plate.

That is necessary to avoid squeezing the tubes (titanium tubes that are thinner than aluminium's).

1 If the wheelchair is equipped with supports for accessories, the adjustment is the same.

If, when possible and wished, you move the support along with the rear wheel plate, you can use the same bolts.

On the other hand, you may need different, in length and type, bolts.

As in the picture, for instance, the bolt 1 fixes only the plate to the frame, the bolt 2 fixes the plate and the support, whereas the bolt 3 fixes only the support.

If you need to lower the rear height, it is necessary to remove the mudguard (if present) before putting the rear wheel on. In fact, the tyre will touch the mudguard.

After adjustment, adjust the mudguard and the brake, too.

2 In some cases, when the requested rear height is particularly high, the wheelchair is provided with a shaped rear wheel plate (right and left only black colour) that allows for higher heights than the regular plate.

The adjustment is the same.

3 Also with the extended rear wheel plate, the adjustment is the same.

Remember that the rear height affects the seat inclination, thus, it is necessary to check and adjust the front fork angle.

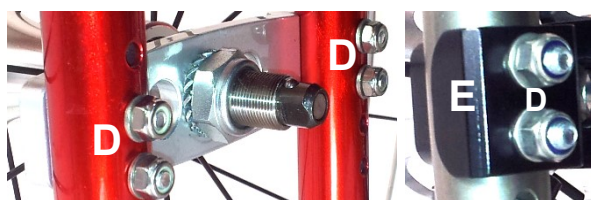
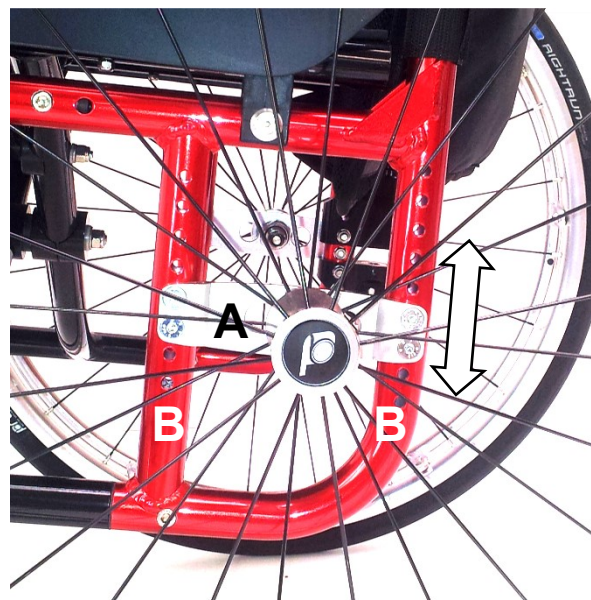

Aluminium frame

Titanium frame

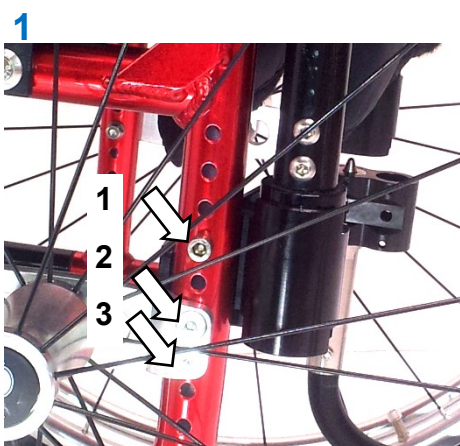

Rear wheel plate plus support for accessories

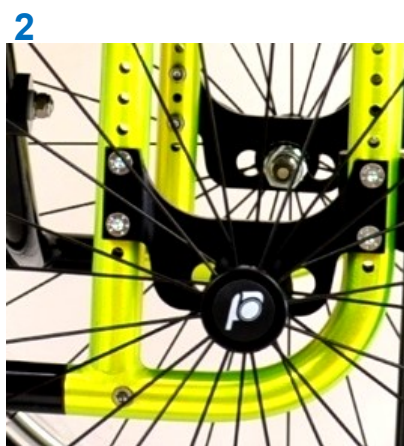

Shaped rear wheel plate for higher rear heights



Extended rear wheel plate for very prudent setting



REAR HEIGHT AND SETTING

Dynamic rear frame (until september 2019)

SERVICE MANUAL

The rear wheel plate **K** is made of two arms **A** fixed, with a joint system, to each other and to the supports **S1** and **S2** that, on their turn, are fixed to the frame.

Before starting the adjustment, it is very useful to consult the chart at the bottom of this instruction. In fact, that chart indicates where and how the parts according to the rear height, setting and rear wheels size.

Before proceeding, we suggest your removing the mudguard (if present).

To remove the mudguard, loosen the two headless bolts and screw off the two bolts. The two parts of the support are now detached and you can remove the mudguard with its support. (In the picture aside, with the only purpose to better show the parts, the mudguard is not present).

Adjustment by moving the receiver.

You can fix the receiver **B** both in one of the two "free hole", **F1** and **F2**, of the arms **A** and in one of the three joints, **J1**, **J2** and **J3** ("joint hole").

Through the "free holes", **F1** and **F2**, insert the receiver **B** and fix it with the nut **D1** and washer **R1**.

Through the "joint holes" **J1**, **J2** and **J3**, the assembly has the adaptation washer **R2** and the M20 threaded made-to-measure counter buckle **D2**.

Then you can insert the receiver **B**, screw it on **D2**, and fix it.

In case of cambered wheels, you have to adjust the convergence through the independent receivers.

You can use the spacers **X** if you need to have the rear wheel more external.

The assembly of the joints **J** has the bolt **V_J**, the made to measure washer **R_J**, the M8 threaded made-to-measure counter buckle **C_J** and the nut **D_J**.

1 If you move the receiver **B** from one "free hole" to the other "free hole", you can use the same parts and the joints **J** are not involved.

2 If you move the receiver **B** from one of the "free holes" to one "joint hole", you first need to remove the nut **D_J**, then the bolt **V_J** and finally **R_J**, **C_J** off the joint **J**.

Now insert **R2** and **D2** into the joint, then insert the receiver and fix it.

In case the counter buckle **C_J** is hard to remove, slightly screw the bolt **V_J** and gently hit it with a hammer.

Should the washer **R_J** be hard to remove, separate the two arms **A**, insert **C_J** and hit it with a hammer a few times. When **C_J** reach the full stroke but **R_J** does not come out yet, lean the head of **V_J** on it and hit it with hammer.

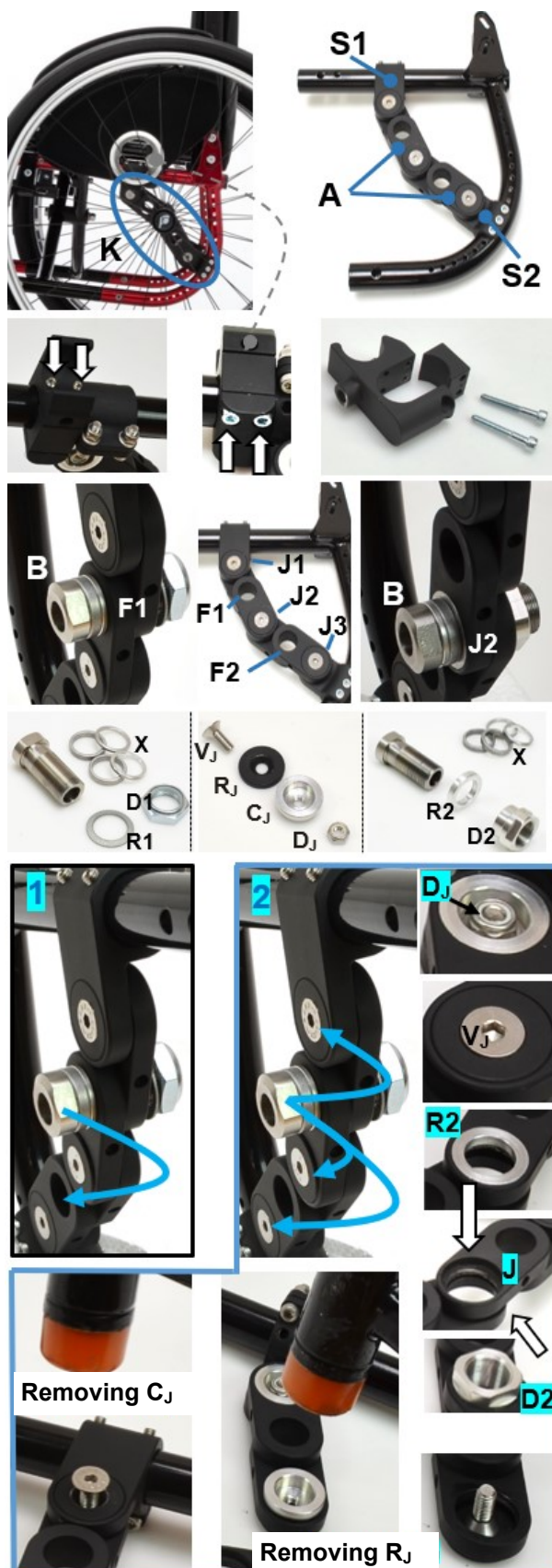

Follows next page



REAR HEIGHT AND SETTING

Dynamic rear frame (until september 2019)

SERVICE MANUAL

3 If you move the receiver **B** from one of the three “joint holes” to a “free hole”, remove the receiver and fix the joint **J** positioning **R_J** and **C_J** first, then screw the bolt **V_J** and finally screw the nut **D_J** while holding the bolt.

To fix the receiver, insert it through the “free hole” and fix it with **D1** and **R1**.

4 If you move the receiver **B** from a “joint hole” to another “joint hole”, remove the receiver and all its parts. Then remove all parts that fix the joint **J** (see instructions of point 2) where you decide to assemble the receiver.

Use the same parts to fix the joint and the receiver to the new points (see instructions of points 2 and 3).

Adjustment by moving the plate

You can adjust the rear wheel position by moving the plate **K** by means of the joints **J** and the supports **S1** and **S2**.

First, loosen the nut **D_J** and then the bolt **V_J** of each joint. If the receiver **B** is fixed to a joint, loosen the receiver.

Loosen the two headless bolts **G_{S1}**, the two bolts **V_{S1}** and nuts **D_{S1}** of the support **S1**.

It is now already possible to slide the support **S1** along the frame. This way the arms **A** will turn and determine new positions for the rear wheel.

After removing the three bolts **V_{S2}**, you can move the support **S2** and fix it in any of the predetermined positions given by the 5 mm pre-drilled holes **H** on the curved part of the frame.

Now, all the system is free to move and you can adjust it, by moving both supports and both arms.

Once you reach the desired position, fix first the support **S2** and then **S1**. Finally the joints **J**.

To adjust the other side in the same position, fix **S2** using the same holes and **S1** at the same distance **DST** from the rear side of the frame.

The last three pictures show three examples. Note that the supports **S1** and **S2** of the picture in the middle and at right are in the same positions, but the arms are differently orientated.

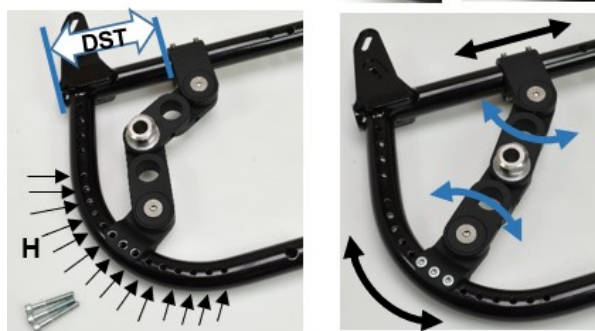
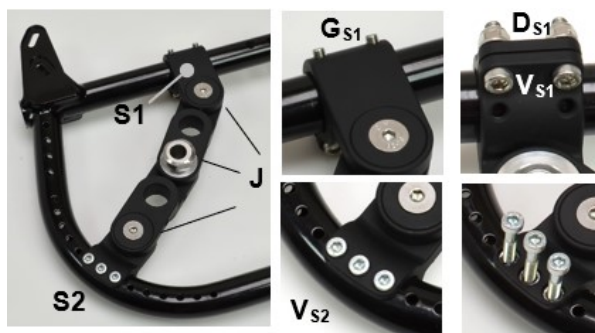
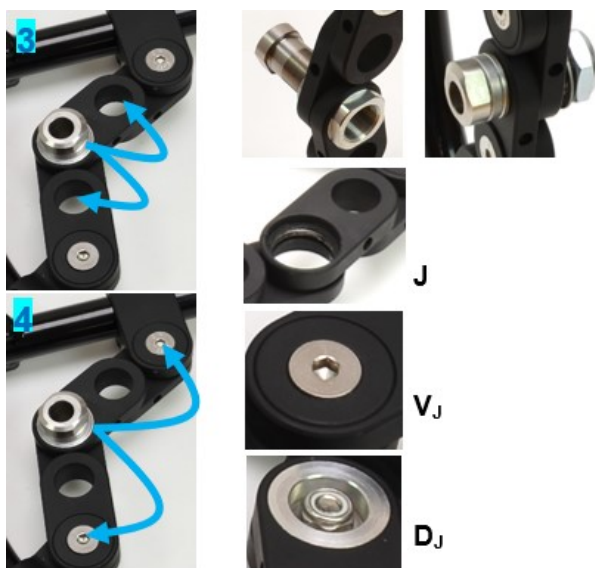

Follows next page



REAR HEIGHT AND SETTING

Dynamic rear frame (first version)

SERVICE MANUAL

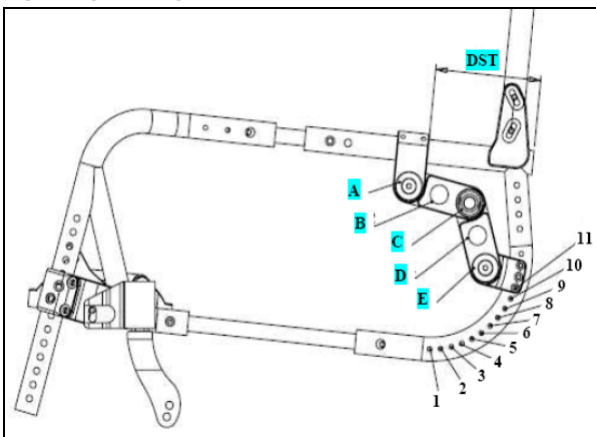

A,B,C,D,E the 5 possible positions for the rear wheel receiver on the rear wheel plate
 1.....11 the holes where to fix the lower support on the frame
 SETT the settings PRUDENTIAL, STANDARD and ACTIVE are determined with a distance "L" between rear wheel axle and backrest axle of approx. 45, 70 e 95 mm respectively.
 DST The distance (in mm) between the rear side of the frame and the upper support
 OR : the orientation of the rear wheel plate, that is the position on the central joint (that is also the possible receiver position C):
 >I = middle joint towards the back;
 <I = middle joint towards the front;
 <> = indifferent
 PSI : Position of the lower support – the number in the chart is to be aligned with the lower hole of the three of the support, the other two come consequently.
 BOC : the letter in the chart indicates what position the receiver has to be fixed in the rear wheel plate.

Dynamic rear frame – rear height adjustment chart

WHEEL 24"	PRUDENTIAL L= 45mm				STANDARD L= 70mm				ACTIVE L= 95mm				WHEEL 22"
	OR	DST	PSI	BOC	OR	DST	PSI	BOC	OR	DST	PSI	BOC	
38	---	---	---	---	<>	77	5	A	<>	100	4	A	35.5
38.5	<>	52	2	A	<>	75	5	A	<>	100	5	A	36
39	<>	55	2	A	<>	110	11		<>	132	11		36.5
39.5	<>	116	11		<>	109	9	B	<>	132	10		37
40	<>	118	11		<>	106	8		<>	126	7		37.5
40.5	<>	114	10		<>	136	11	c	<>	124	6	B	38
41	<>	114	9		<>	99	4	B	<>	118	1		38.5
41.5	<>	109	8		<>	135	10		<>	118	1		39
42	<>	106	7	C	<>	132	9		<>	96	6		39.5
42.5	<>	101	6		<>	125	7		<>	143	11	c	40
43	<>	99	5		<>	127	7	C	<>	---	---	---	40.5
43.5	<>	93	4		<>	120	5		<>	135	9		41
44	<>	89	3		<>	112	2		<>	60	1		41.5
44.5	<>	78	2		<>	106	1		<>	124	7	C	42
45	<>	119	8		<>	108	1		<>	82	7		42.5
45.5	<>	115	8		<>	70	10		<>	95	9		43
46	<>	111	7	D	<>	100	11		<>	91	10		43.5
46.5	<>	90	5		<>	70	8		<>	---	---	---	44
47	<>	88	5		<>	100	8	D	<>	---	---	---	44.5
47.5	<>	70	4		<>	115	3		<>	132	1		45
48	<>	60	3		<>	106	2		<>	115	1	D	45.5
48.5	<>	55	3		<>	78	1		<>	110	2		46
49	<>	100	7		<>	---	---	---	<>	---	---	---	46.5
49.5	<>	70	6		<>	---	---	---	<>	---	---	---	47
50	<>	105	6	E	<>	---	---	---	<>	---	---	---	47.5
50.5	<>	105	5		<>	105	3		<>	---	---	---	48
51	<>	---	---	---	<>	110	3	E	<>	117	1	E	48.5
51.5	<>	---	---	---	<>	---	---	---	<>	115	1		49

Notes: all combinations are worked out considering a seat inclination equal to 4 cm on a seat depth 40 cm (which is like 3 on 30 and 3.5 on 35) and with standard high pressure tyres. **The rear height may result quite different if** the inclination of the seat is very different from that used as reference (*especially with active setting*). In fact, the rear height reported in the chart is proportionally affected by the seat inclination difference, more inclination = lower rear height

For 1 cm of inclination, such change is approximately: 1 mm with PRUDENTIAL setting; 2 mm with STANDARD setting; 2,5 mm with ACTIVE setting.

Example: rear height 43 cm with active setting and seat inclination 8 cm on seat depth 40cm (4 cm more than reference), result $43 - (4 \times 0,25) = 42$ cm; but with flat seat (4cm less than reference), result $43 + (4 \times 0,25) = 44$ cm.

The configuration of the rear wheel plate to follow will therefore be that on the row with height 44 (44 -1=43) in the first case, while, in the second case it will be that with height 42 (42 + 1 = 43).

You can obtain quite a few combinations *height / setting / rear wheel* with different rear wheel plate positioning; this chart, for simplicity, reports only one.

On the other hand, many more configurations with other settings are possible; this chart reports the three most common settings.

If necessary, contact Rehateam s.r.l. for technical help.



REAR HEIGHT

Dynamic 2.0 rear frame

SERVICE MANUAL

Adjustment every 1,5 cm

You can adjust the rear height by changing the position of the receiver **A** on the plate **B**.

Screw off the nut **C**, remove the receiver and insert it in another hole.

Pay attention to the position of the toothed washer **D** and to the spacers **E** (if any).

Securely fix the receiver.

If you lower the rear height, then you have to remove the mudguard (if present) before inserting the rear wheel; in fact, the wheel will touch the mudguard.

After adjustment, adjust the mudguard and the brake, too.

Remember that the rear height affects the seat inclination, thus, it is necessary to check and adjust the front fork angle.

Should the receiver be with camber, make sure to adjust the convergency — see chapter “camber”.

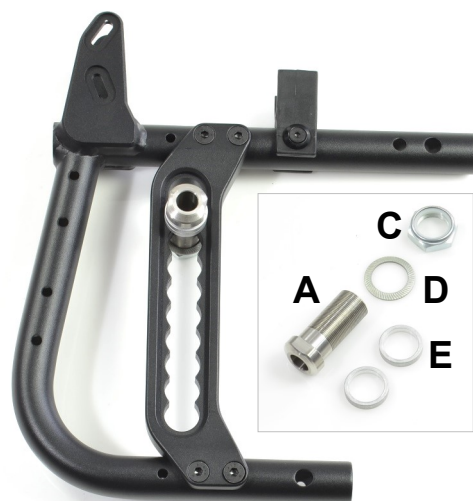
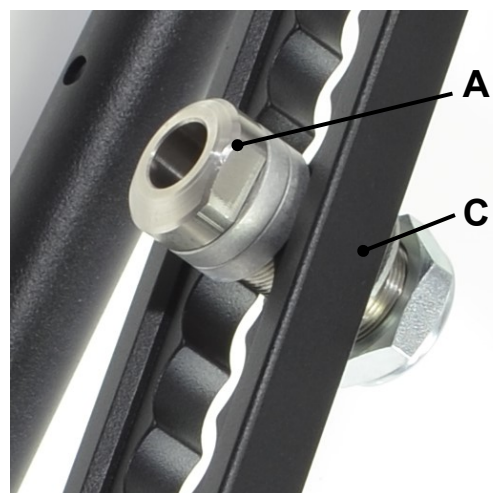
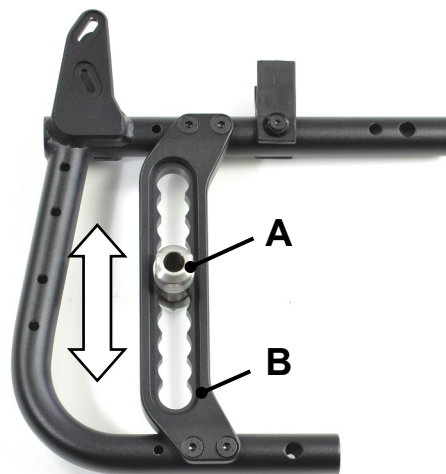

For the adjustment of the fork angle and the removal of the fork support, see chapters “fork angle” and “fork support position”



SETTING ADJUSTMENT (point of balance)

Standard rear frame

SERVICE MANUAL

You can adjust the setting by changing the position of the receiver **B** with respect to the plate **A**, but also by turning the plate.

To carry out the adjustment, simply remove the receiver **B** and its parts (nut **D**, washer **C** and, if present, spacers **E**) and fix it to the new position.

You can use the spacers **E** in case you need to have the rear wheel more external.

In the picture 1, the settings are:

F1 = Prudential (35 mm) ; **F2** = Standard (60 mm) ; **F3** = Active (85 mm) .

Even if the holes **F** of the plate are 3, the possible settings are 6. In fact, the 3 holes are not centred with respect to the plate, thus, if you turn the plate by 180°, the position of the holes with respect to the frame, change.

To turn the plate, remove the 4 bolts **G** and nuts and washers **H** and fix it to the reverse position.

In the picture showing and comparing the two plates, you can see the black one "180° turned". Consequently, the 3 holes are now approximately 1 cm ahead.

Therefore, the settings change and, in fact, **F1** = Extreme (100 mm) (in picture 1, **F1** was Prudential).

In both small pictures, the receiver is fixed through **F1** of the black plate, but the plate is differently fixed to the frame. At left, the setting is Prudential, at right it is Extreme.

In case of cambered wheels, you will see washers between the plate and the frame, such washers are necessary to tilt the plate and, thus, to give the camber. In that case, to keep the camber, you have to assemble the washers in the same way.

 If case of titanium frame, the assembly has an extra counter plate on each side of the plate. That is necessary to avoid squeezing the tubes (titanium tubes that are thinner than aluminium's).

After changing the setting, adjust the mudguard and brake. Also, check and adjust the front fork angle.

In some cases, when the requested rear height is particularly high, the wheelchair is provided with a shaped rear wheel plate (right and left only black colour) that allows for higher heights than the regular plate. The adjustment is the same.

 The extended rear wheel plate (only black colour), allows for 4 settings between prudential and Extreme and 2 Extremely Prudential (behind the backrest axis).

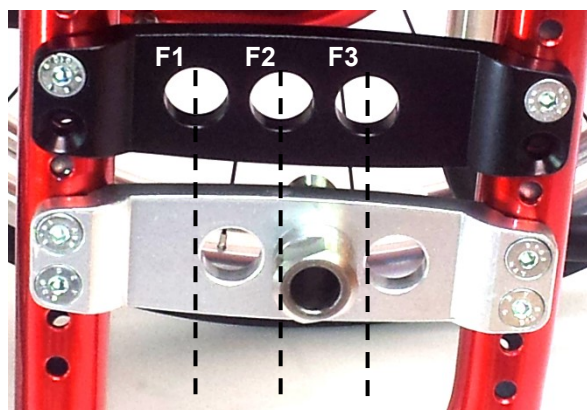
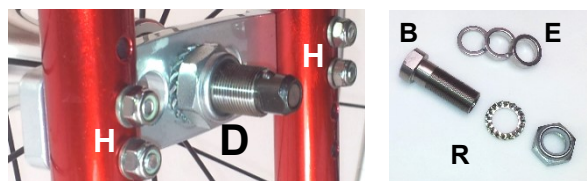
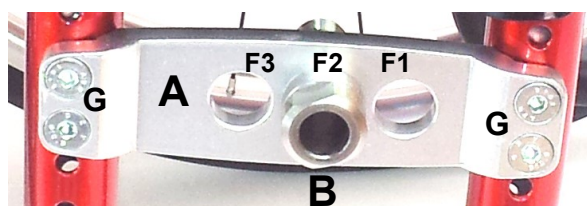



SERVICE MANUAL

SETTING (point of balance)

Dynamic 2.0 rear frame

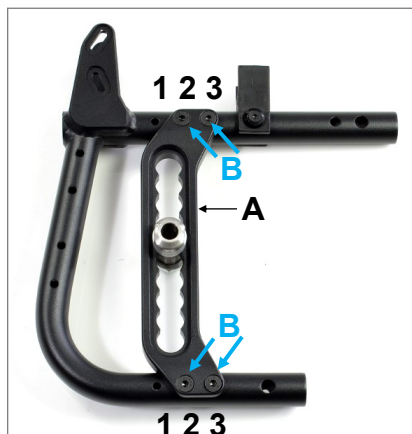
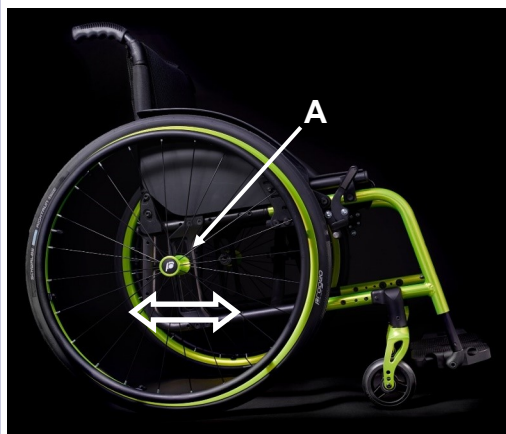

You can adjust the setting (point of balance) by moving the rear wheel plate **A** along the frame.

There are three pre-drilled holes (1 2 3) on the frame, therefore, two positions.

The rear wheel plate can be assembled facing either forward or rearward.

The possible setting, thus, are 4: **prudential, standard, aactive, extreme.**

Interval 20 mm.



PRUDENTIAL (35 mm)



STANDARD (55 mm)



ACTIVE (75 mm)



EXTREME (95 mm)

After changing the setting, adjust the mudguard and brake.

Also, check and adjust the front fork angle.



SERVICE MANUAL

SIDE GUARD

Standard rear frame

After any adjustment of the rear wheel, you will have to adjust the position of the side guard accordingly.

You should adjust the side guard at approximately 5 mm from the tyre. It is fixed to the frame in two points: to the backrest tube with a ring **A** that can slide along the same tube; to the plate of support **B**.

If the side guard is straight, you can decide to modify it or not.

A

When you decrease the rear height, you have to move the side guard up.

1. After the rear height adjustment, remove the bolt and nut **C1 C2**.
2. Loosen the bolt **D**, slide the side guard upward even beyond the necessary and temporarily fix it just enough to let it stay where you position it.
3. Put the rear wheel on and position the side guard at approximately 5 mm from the tyre and parallel to it. Remove the rear wheel, fix the bolt **D** and put the rear wheel back on.
4. While keeping the side guard at 5 mm from the tyre, from the outside of the plate of support **B**, mark the point where you will have to drill a new hole (however, check whether you can use the same hole).
5. To do so, use a pointed tool and let it through the slot of the plate. It is advisable to mark it in the middle of the slot. If the rear height adjustment is remarkable, you may need a new side guard.
6. Drill a 5 mm hole on the mud guard where just marked.
7. Countersink the hole.
8. Insert the bolt, washer and nut **C1 C2** and fix the side guard.
9. Adjust the brake.

B

When you increase the rear height, you have to move the side guard down.

1. After the rear height adjustment, remove the bolt and nut **C1 C2**.
2. Lean the side guard on the outside of the plate of support.
3. Loosen the bolt **D** just enough to move the side guard, put the rear wheel on and position the side guard at approximately 5 mm from the tyre. Remove the rear wheel and fix the bolt **D**.
4. Draw a line on the lower side of the side guard considering that, when finally assembled, it will lean on the spacer of the plate of support. The side guard cannot go down beyond that spacer.
5. Remove the bolt **D** and remove the side guard.
6. Saw the side guard along the line you have just drawn and round off the edge with a blade of a scissor or with fine sand paper.
7. Assemble the side guard and slightly fix it with the bolt **D**.
8. Continue following the points 3 to 9 of the adjustment **A**.

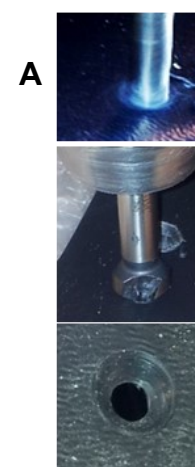
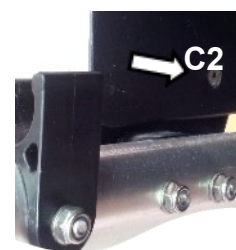
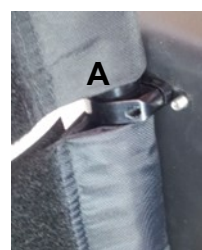
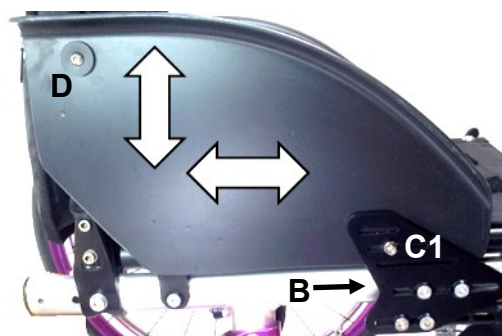

Follows next page



SERVICE MANUAL

SIDE GUARD

Standard rear frame

C

When you change the setting, you have to move the side guard frontward or backward according to the new position of the rear wheel, but the height of the side guard remains the same.

1. After the setting adjustment, remove the bolt **D**.
2. Loosen the two bolts and nuts **E1 E2** fixing the plate of support **B** to the frame.
3. Put the wheel on and slide the plate **B** forward or backward. Position the side guard at 5 mm from the tyre. If necessary, you can loosen the bolt and nut **C1 C2** and slide the side guard or you can also fix the plate **B** over the seat tube support **F** with the bolt and nut **G1 G2**.
4. Fix the two bolts and nuts **E1 E2** (o **E1 E2 + G1 G2**).
5. You have now to drill a new hole for the bolt **D**. With a pointed tool through the hole of the ring **A**, make a mark on the side guard.
6. Drill a 6 mm hole
7. Insert the bolt and washer **D** and fix the side guard. Make sure to fix bolt and nut **C1 C2**, too.
8. Check and if necessary adjust the brake.



D

When you change both the rear height and the setting, you have to move the side guard up or down and forward or backward.

1. After the rear wheel height and position adjustment, remove the bolt **D** and the bolt and nut **C1 C2**. This way you remove the side guard.
2. Put the wheel on.
3. Adjust the brake by moving the plate of support **B** along the frame (see points 2 and 3 of the adjustment **C**).
4. Position and hold with one hand the side guard at approximately 5 mm from the tyre and parallel to it (you can lean the side guard on the outside of the plate of support as in adjustment).
5. You have now to drill a new hole for the bolt **D**, thus, while holding the side guard in position, make a mark on the side guard with a pointed tool through the hole of the ring **A**.
6. Drill a 6 mm hole.
7. Insert the bolt and washer **D** and fix the side guard.
8. Follow points 4 to 8 of adjustment **A** or **B** according to the adjustment.
9. If the slots of the plate **B** do not allow fixing the side guard, you may move it accordingly.
10. Finally check and, if necessary, adjust the brake.



SIDE GUARD

Rotative system

SERVICE MANUAL

After any adjustment of the rear wheel, you will have to adjust the position of the side guard accordingly.

You should adjust the side guard at approximately 5 mm from the tyre.

You can adjust the side guard in height and depth.

The side guard is fixed through an eccentric ring that, in its turn, is fixed through the bolt **A** through the support **S**.

To carry out the adjustment, proceed as follows.

Insert the rear wheel and, if there is no interference with sideguard, you keep it on. On the other hand, remove the wheel and proceed.

The system consists of the rotation of two components.

A rotation of the whole system (side guard and ring fixed together);

B rotation of the side guard on the ring.

The combination of these two rotations allows for the adjustment.



A

ROTATION OF THE WHOLE SYSTEM

Loosen the nut **B** that is located in the inner side of the frame and the headless bolts **C**. That will allow for the rotation of the whole system pivoting it on the bolt **A** (in this phase, the ring and the side guard are still fixed to one another).

To rotate the whole system, just take hold of the side guard with one hand and rotate it clock/anticlockwise.

Note: if you loosen the nut **B** too much, it may happen that the bolt **A** moves as far as to have its square neck **D** off its corresponding bed **E** on the ring. Therefore, when you screw the bolt **A**, pay attention this bolt is correctly inserted in the ring, otherwise it will not be possible to tighten the nut **B** and, consequently, the whole system.

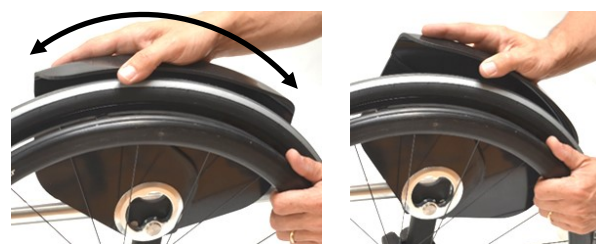
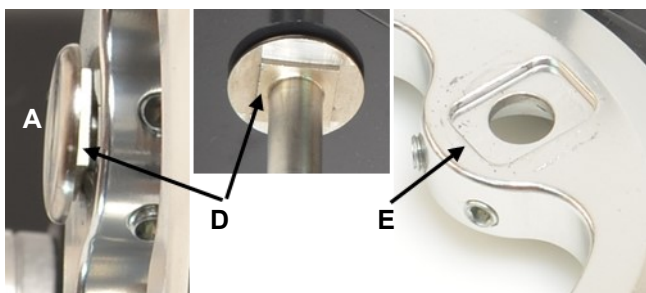
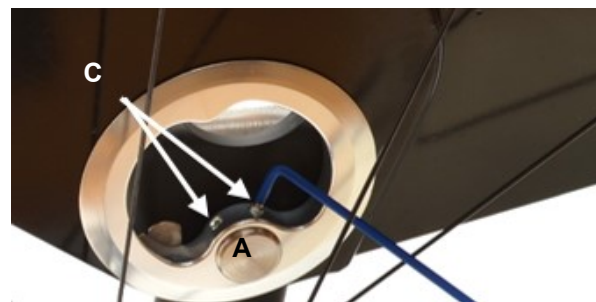
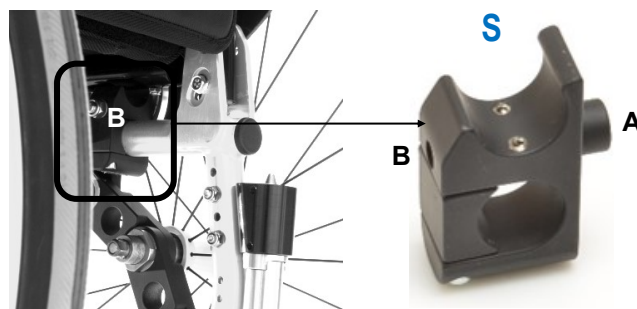

It is advisable to spread a drop of mild lock thread glue on the grab screws **C** and **G** and on the bolt **F**.

Follows next page



SIDE GUARD

Rotative system

SERVICE MANUAL

B

ROTATION OF THE SIDE GUARD ON THE RING

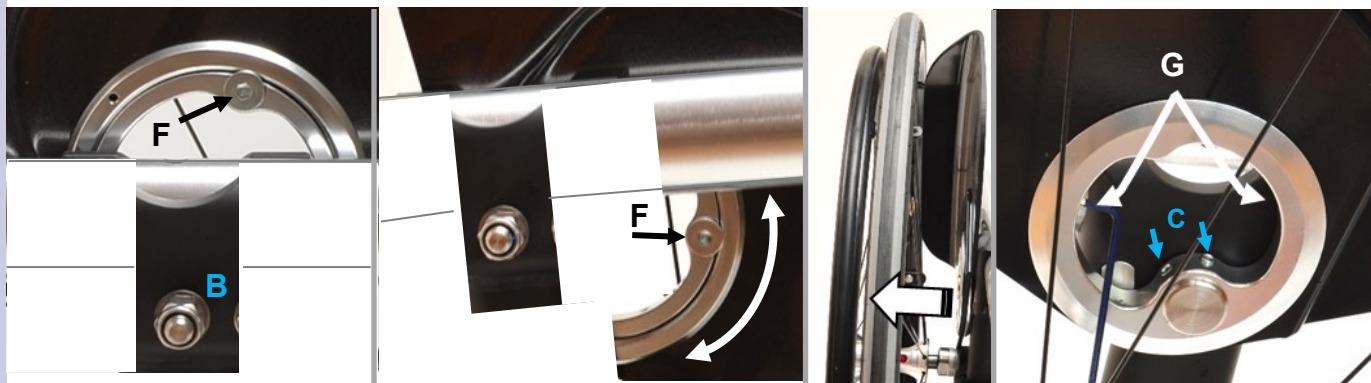

Loosen the nut **B**, the bolt **F** and the grab screws **G**. That will allow rotating the side guard pivoting it on the ring. To rotate the side guard, hold the ring with one hand and turn the side guard with the other hand.

If the bolt **F** is not accessible, loosen the two grab screws **C** and turn the whole system (as explained in the paragraph **A**) until this bolt becomes accessible. To do so, slide the wheel off by 3 cm approximately to avoid the interference, or remove it.



C

POSITIONING THE SIDE GUARD

Remove the rear wheel and, working on two rotations above mentioned, take it to its maximum height and put the wheel back on.

Now, working again on the two rotations, position the side guard at approximately 5 mm from the tyre.



It is advisable to spread a drop of mild lock thread glue on the grab screws **C** and **G** and on the bolt **F**.



SIDE GUARD

Rotative system

SERVICE MANUAL

D

FIXING THE WHOLE SYSTEM

Tighten the bolt **F** and the two grab screws **G** - see also **B** (*ROTATION OF THE SIDE GUARD ON THE RING*)

If the bolt **F** is not accessible after you positioned side guard, tighten the two headless bolts **G**, then, taking care of not letting the side guard turn on the ring, rotate the whole system clock/anticlock wise until you will be able to get access to the bolt and tighten it.

If necessary, slide the wheel off by 3 cm to allow the side guard passing.

Note: the bolt **F** may be "hidden" just by the seat tube of the crossbar, in such case, fold the crossbar as much as necessary.

Turn the whole system back to the correct position.

Tighten the nut **B** hard while holding, checking and, if necessary, correcting the position of the side guard that may move. Finally, tighten the headless bolts **C**.

See also **A** (*ROTATION OF THE WHOLE SYSTEM*)

Before tightening the nut, open the seat and let it lock to the four supports. Two of such supports are integrated to the side guard support. Make sure to position/hold the support, thus the side guard, perpendicular to the ground.

NOTES

These kind of side guards (plastic or carbon fibre) allows for 5-6 cm range of adjustment.

Therefore, it may be necessary to change the side guards with smaller or larger ones.

The height **H**. can be:
21 cm (mini);
25 cm (small);
28 cm (large).

If the position of the side guard is not satisfactory, you can also work on the sliding support **S** that you can assemble in front or behind the rear wheel plate upper support **L**.

To slide the support **S** just loosen the two bolts **M** and the two grab screws **N** present on the upper side of the support (you have to fold the crossbar to get access to them). To move it in front or behind the support, remove the two bolts **M** (by doing so, you can remove the block **O**), remove the support **S** and fix it to the new position.

Once you find a suitable position, insert the block **O**, tighten the bolts **M** and the two grab screws **N**.

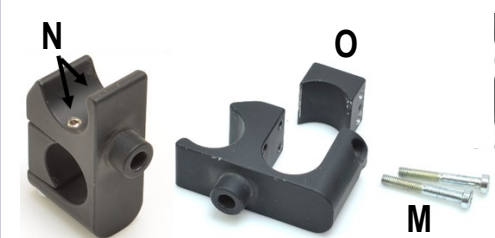

It is advisable to spread a drop of mild lock thread glue on the grab screws **C** and **G** and on the bolt **F**.

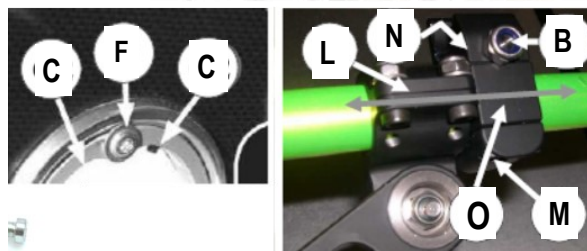

Follows next page



SIDE GUARD

Removable with blade system

SERVICE MANUAL

After every adjustment of the rear wheel, you have to adjust the position of the side guard. You have to adjust the side guard at approximately 5 mm from the tyre. The side guard is fixed to three points on the blade **A** that slides in the support **B** fixed to the frame.

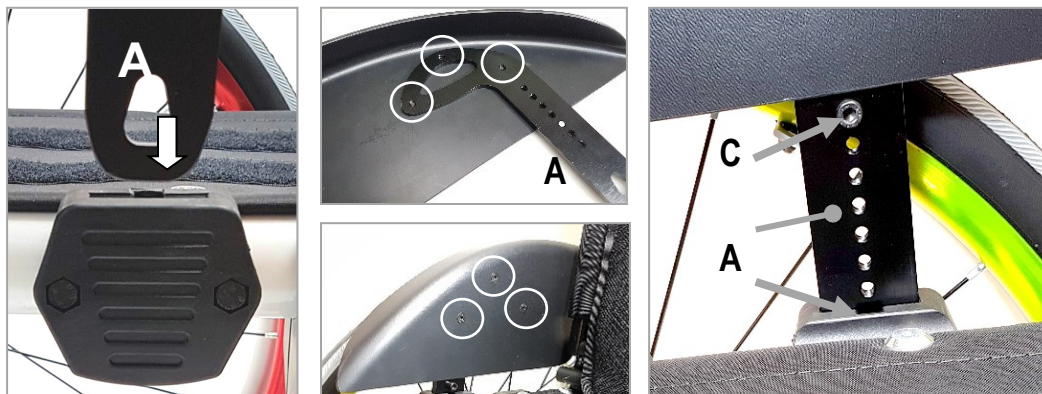

Height adjustment: the blade **A** shows, in its vertical side, a series of holes to fix the bolt **C** that inserts in the hollow **D** of the support **B**. Therefore, to change the height, just remove the bolt **C** and screw it in another hole.

WARNING: do not tighten the bolt **C** excessively: it may damage the threaded hole until making it unusable.

Side guard modification: If one, the other or the combination of both adjustment above mentioned are not satisfactory, you can modify the side guard.

Every side guard is shaped to measure according to the configuration of the wheelchair when originally assembled.

The shape of the side guard always allow for a reasonable good range of adaptation.

Note: if the side guard is straight, you can decide to modify it or not.

A WHEN YOU DECREASE THE REAR HEIGHT, you have to move the side guard up.

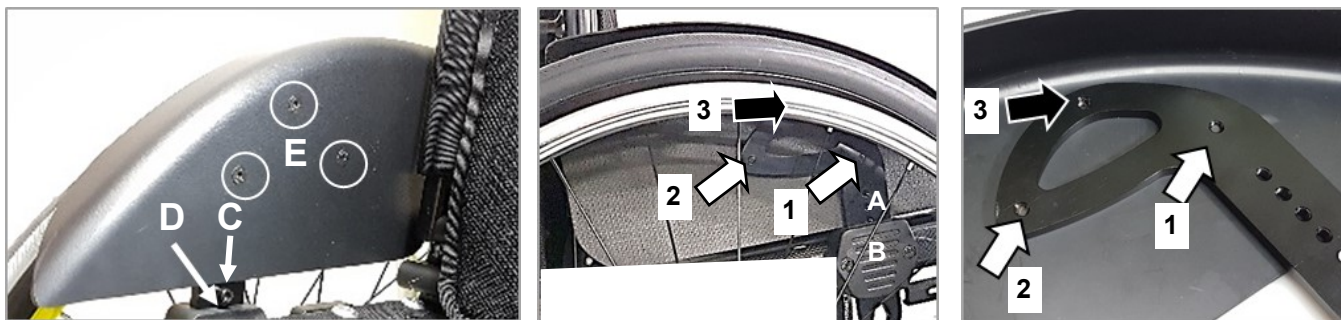

1. Remove the three bolts **H** to take the side guard off the blade.
2. Position the side guard at approximately 5 mm from the tyre, always leant on the blade **A**. The bolt **C** on the blade must be inserted in the hollow **D** of the support.
3. While holding this position, mark the point where it is necessary to drill the first new hole (1 or 2; 3 is usually not accessible with the rear wheel on).
4. To do so, use a point and let it through the accessible hole. If the rear height adjustment is remarkable, you may need a new sideguard.
5. Drill a 5 mm on the sideguard where you have marked it.
6. Countersink the hole.
7. Insert and screw the bolt **H**.
8. To drill the second hole on the side guard, follow instruction from 3 to 7.
9. To drill the third hole, remove the side guard, mark the point where to drill and follow instruction from 5 to 7.



It is advisable to spread a drop of mild lock thread glue on the bolts **E** and **C**.

Follows next page



SERVICE MANUAL

SIDE GUARD

Removable with blade system

Advice for drilling. While drilling a hole, such hole may result slightly moved with respect to the precise point you marked. For the first hole, that move does not cause any trouble. On the other hand, for the second and third hole, it may cause a non-alignment between hole on the side guard and hole on the blade. A good method to be more precise, once you reach point 5, is to use a 4 mm drill pin (in order to avoid damaging the thread of the hole on the blade) and drill the side guard. Then, use and let a M5 tap through the threaded hole of the blade and out of the side guard.

B WHEN YOU INCREASE THE REAR HEIGHT, you have to move the side guard down.



If the lower side of the side guard is in contact with the support, it is necessary to cut it.

1. Measure the distance **X** from side guard and tyre and subtract 5 mm (es: $18-5 = 13$ mm to cut).
2. Remove the three bolts **H** to take the side guard off the blade.
3. Draw the cut line according to the result you got.
4. Saw the side guard along the drawn line and round off the edges with a scissors blade or thin sand paper.
5. Continue with instruction **A**.

C WHEN YOU CHANGE THE SETTING, you have to move the side guard forward or backward according to the new position of the rear wheel, but the height of the side guard remains the same.

Proceed with instruction **A**.

D WHEN YOU CHANGE BOTH THE REAR HEIGHT AND THE SETTING, you have to move the side guard up or down **and** forward or backward.

Continue with instruction **A** and, if necessary, instruction **B**, too.



CAMBER

Standard rear frame

SERVICE MANUAL

The camber on the model Exelle/Exelle Vario standard frame is given by the inclination of the rear wheel plate **b** with respect to the frame **A**.

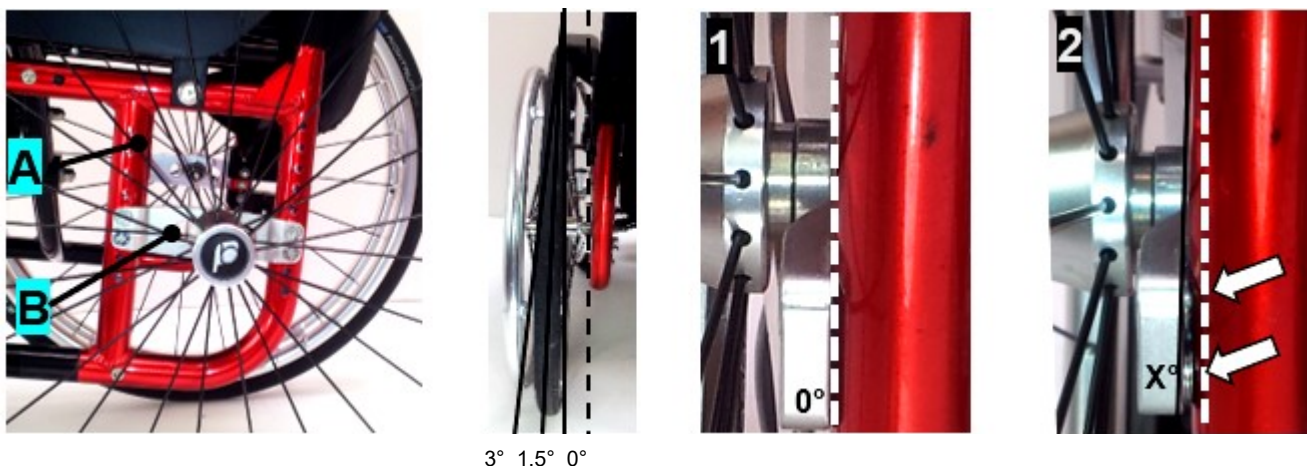

3° 1.5° 0°

The inclination of the plate **B** depends on the presence or not of 0.5 mm washers properly positioned under the same plate.

Picture 1 shows that the plate **B** is perfectly aligned with the frame tube, thus, there is no camber (0°).

No washer is present.

On the other hand, picture 2 shows that the plate **B** is tilted with respect to the frame tube and the arrow indicates the washers, thus, there is camber.

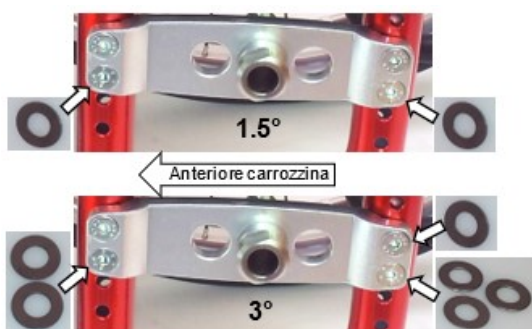

If case of **titanium frame**, the assembly has an extra counter plate **E** on each side of the plate. That is necessary to avoid squeezing the tubes (titanium tubes that are thinner than aluminium's).

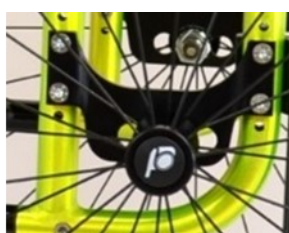

To have a 1.5° camber, you need, for each side of the wheelchair, 2 pieces of 0.5 mm washers between the plate **B** and the frame **A**, positioned as shown here aside. With such camber, the convergence is within tolerance. However, should the seat inclination be remarkable, you may add one 0.5 mm washer on the rear fixing points of the plate.

To have a 3° camber, adjusting the convergence, too, you need, for each side of the wheelchair, 6 pieces of 0.5 mm washers between the plate **B** and the frame **A**, positioned as shown here aside.

Should you need to eliminate the camber, you will simply need to remove the plate **B** (bolts, washers and nuts **D**) and then all washers between the same plate **B** and the frame **A**.

On the other hand, remove the plate **B** and add all washers under it as earlier shown.

The maximum camber allowed is 3°; therefore, it is not permitted to add more washers than what above mentioned.

In presence of supports for accessories, the adjustment is the same.

With the extended rear wheel plate and with the shaped rear wheel plate, the adjustment is the same but you have to use 1.5 mm washer due to the distance between the fixing bolts is 3 cm instead of 1.5 cm.

If you increase the camber, the rear wheel may get too close to the side guard or even interfere with it: in such case. It is necessary to add a spacer on the rear wheel receiver.



CAMBER

Dynamic rear frame (first version) and Dynamic 2.0

SERVICE MANUAL

WORK ON A FLAT AND EVEN SURFACE

With cambered wheels, it is necessary to adjust the convergence in order to make the wheelchair very fluent.

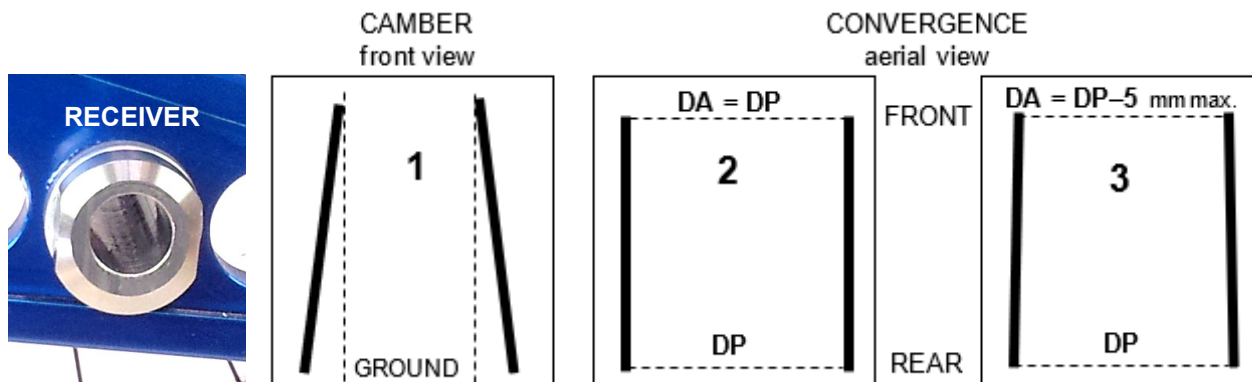

The wheel receiver gives the rear wheel camber (cambered receiver).

The receiver is fixed to the rear wheel plate and, to adjust the convergence, it is necessary to turn the same receiver.

The two receivers are independent; therefore, their adjustment is independent, too.

The drawing 1 shows same inclination (camber) of both rear wheels.

With cambered wheels, it is necessary to check/adjust the convergence, the distance between the two wheels in front and at rear.

The drawing 2 shows the aerial view of the wheels and the front distance **DA** is equal to the rear distance **DP**, while the drawing 3, **DA** is narrower than **DP** by maximum 5 mm.

We can say that a good convergence has the front distance **DA** equal to or slightly narrower than the rear distance **DP**.

DA must not be wider than **DP**. In such case, the fluency of wheelchair will not be good.

CHECKING THE CONVERGENCY

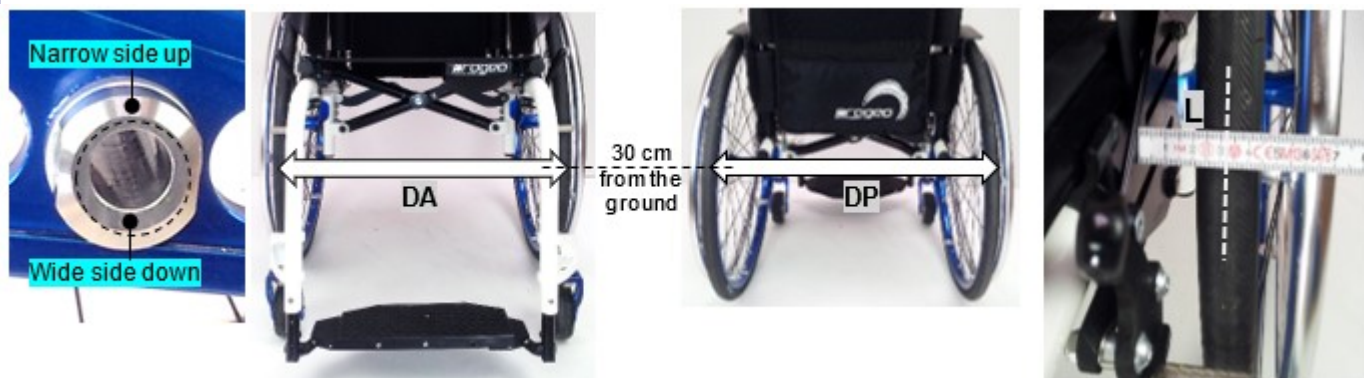

The hole of the cambered receiver, since it is inclined, is not centred.

Therefore, check the wheel receiver its narrow edge looking upward and its wider edge down. If opposite, the convergence is opposite, too (the wheels are opening apart at top!).

At 30 cm from the floor, take the measure centre-to-centre between the two tyres in front and at rear.

If the two measures are equal or the front one is slightly narrower (max. 5 mm), the convergence could be good as in drawings 2 or 3.

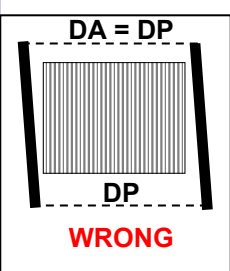

In fact, even if these measures are respected, there may be a wrong adjustment, that is, the wheels could be parallel between themselves but not with the frame.

Therefore, it is necessary to take the measurement **L**, on both sides of the wheelchair, from a fixed point of the frame (or of a support fixed to it) to the centre of the tyre.

If the measurements **L** are different, it is necessary to adjust this aspect, too.

Follows next page



CAMBER

Dynamic rear frame (first version) and Dinamic 2.0

DYNAMIC (first version)

DYNAMIC 2.0

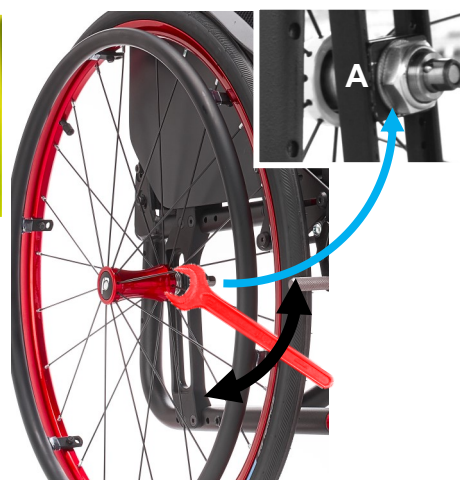
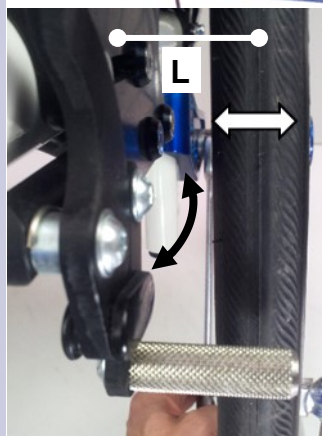
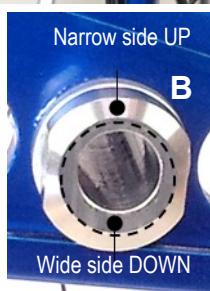
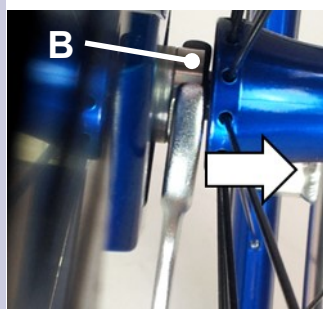

Slightly move away the rear wheel to get access to the receiver **B** and get hold of it with the spanner. Check the receiver **B** is correctly orientated as above mentioned, otherwise, adjust it now.

Loosen the nut **A** (that fixes the receiver **B**) just enough to be able to turn the receiver with the spanner, but without creating play.

To understand to what direction and to what extent the wheel moves sideward, try to observe its movement while turning the receiver clock and anticlockwise. You can measure it with the difference of the distance **L** (always with the wheel fully inserted into the receiver) before and after turning the receiver. If the distances **L** at right and at left are different, move one wheel closer or move the other away in order to make them the same.

Now, measure the front distance **DA** and the rear distance **DP**.

If the front distance **DA** is wider than the rear distance **DP**, you have to turn the receiver to draw the wheel near the front frame.

If the front distance **DA** is narrower than the rear distance **DP**, you have to turn the receiver to move the wheel away from the front frame.

Every time you turn the receiver, it is advisable to insert the wheel and measure the change of the distance **L** and the distances **DA DP**.

Example 1: **DA** 8 mm wider than **DP** (the wheelchair will not be very fluent), we have to decrease the **DA** by 4 mm, in fact, by doing so, we will also increase the **DP** by 4 mm; one deduces that the adjustment for each wheel is 2 mm.

At this stage, **DA** and **DP** will be the same.

Example 2: **DA** 6 mm narrower than **DP** and distance **L** right 2 mm wider than **L** left.

We have to increase **DA** by 3 mm but we also have to equal the distances **L**.

We thus increase the distance **L** left by 2 mm.

By doing so, we have also increased **DA** by 4 mm, therefore, the difference **DA - DP** is now $6 - 4 = 2$ mm. It can already be good, or we can make it better if we adjust each wheel by 0.5 mm: **DA** increases by 1 mm and **DP** decreases by 1 mm, therefore a total of 2 mm; finally, **DA = DP** mm ($6 - 4 - 2 = 0$).

After adjustment, tighten the nut **D** hard while holding the receiver **B**. It is not necessary to remove the wheel, but move it away just enough to make the receiver accessible.

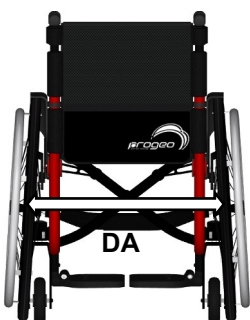



SERVICE MANUAL

BRAKE WITH SUPPORT PLATE

YOU HAVE TO ADJUST THE BRAKE WHEN THE WHEELS ARE PROPERLY INFLATED (except solid tyre)

The position of the brake depends on the position of the rear wheel.

To adjust the brake.

Loosen the two bolts **B** that fix the brake to the plate of support **A**.

Position the brake-knurled rod **C** at a distance **D** of a few millimetres and parallel to the ground.

Temporarily fix one of the two bolts **B** and try the brake to check whether the adjustment is good.

If necessary, repeat the same operation until reaching the good adjustment.

A good adjustment has the brake not too hard to engage but braking, so you will have to find the suitable compromise.

Once you get the correct adjustment, tighten both bolts **B** properly

Proceed in the same manner on the other side.

If the range of adjustment is not enough, you can use any of the four slots of the brake rod. Therefore, loosen the two bolts **B** until you can detach the brake. Then position the brake differently. To hold the nuts **E** you do not need the spanner because their housing will hold them.

It is also possible to move the plate of support **A** along the frame.

Loosen the bolts **G** holding the nuts **L**.

Loosen the bolt **F** and the nut **H** that fix the side guard in front. Now you can slide the plate of support **A**. If the slot through which the bolt **F** is fixed does not allow a sufficient run, remove this bolt (then you will need to drill a new hole on the side guard).

Observe the position of the plate in the different images. In particular, in the image 2, you can see the plate touching the bolt **N** that fixes the seat tube support **M** and thus the plate cannot move beyond that point. However, you can fix the plate over the support **A** as shown in the image 3.

Therefore, remove the more backward bolt **G** and the bolt **N** with their corresponding nuts **L** and **I**.

Assemble the plate **N** and adjust its position (the just removed bolt **G** is not necessary any more).

According to the model and to its frame length, there will be different fixing holes for the bolts **B**, **G** and **N**.

Also, note the position of the bolt and nut **V3 A3** that fix the side guard. According to the adjustment due to the changing of the position of the rear wheel, you may need to modify the side guard.

You can adjust the brake using on any of the above-mentioned methods, individually or in combination.

When you change setting (same rear height but rear wheel more forward or backward), it will be easier to move the plate **A**, in fact, by doing so, you will also move the side guard (after removing its rear fixing bolt) and the brake by the same extent.

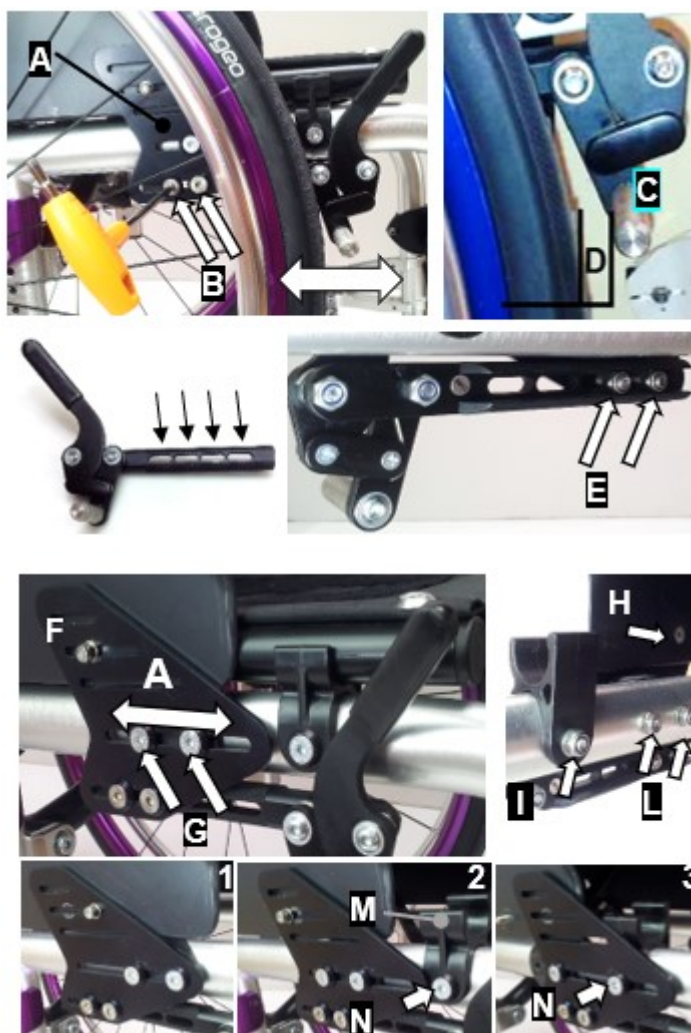

Follows next page



SERVICE MANUAL

BRAKE WITH SUPPORT PLATE

The adjustment of the sport brake is the same except for:

The distance **D**, in fact, in its resting position, the brake is far from away from the tyre. Just make a few tries.

The brake support **O** has only one fixing position, but it can slide along the slot of the plate **A**.

When you loosen the bolts **B**, you have to hold the nuts **E** with a spanner.

You can adjust the brake position by sliding its rod through the support **O** after loosening the grab screw **P**.

For the models EXELLE and EXELLE VARIO with plate of support, the adjustment of the brake is the same even if their frames are different from one another.

For the same model, even its frame length can be different, but that does not change the adjustment procedure.

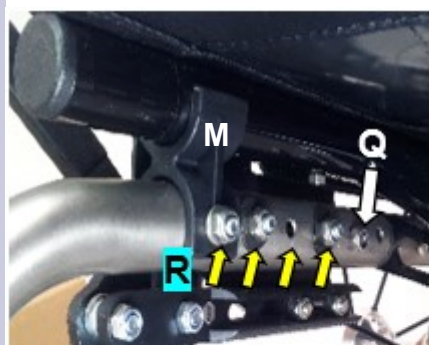
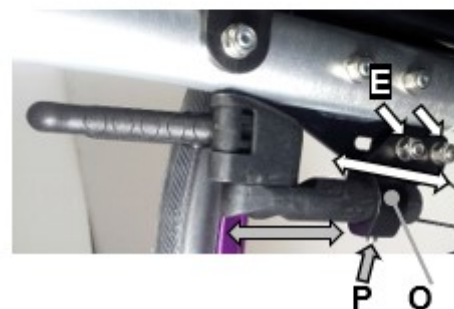
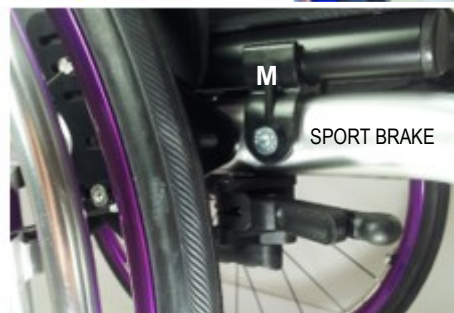

NEVER USE the holes through which the bolt and nut **T** fix the frame to the inner connection tube.

The plate of support should always be spaced from the frame in at least two points through the holes **R** and using the specific spacers **S** or with the seat tube support **M**.

In some case, for the model Exelle Vario there may be interference between brake and front frame. That will impede the correct adjustment of the brake.

There are two solution to that problem.

- 1) Move the rear wheel backward (more prudential setting)
- 2) Space the plate of support from the frame (max. 5 mm), remove the bolt **T** and its corresponding nut, cut off approx. 5 mm the point of the bolt, slightly squeeze the thread with a pincers, spread some strong thread lock glue and screw the bolt hard. No need of the nut.

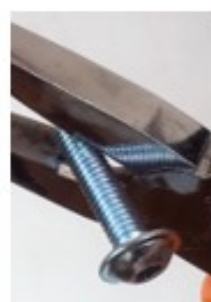
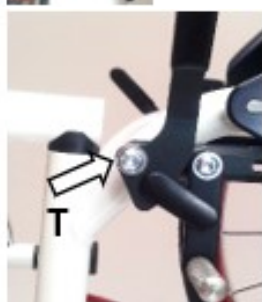
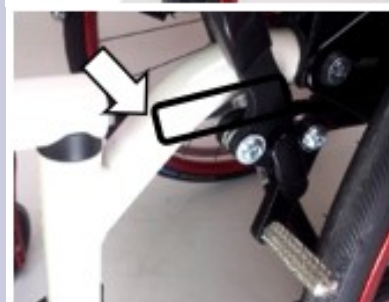
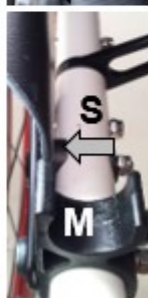



BRAKE WITH CLAMP

SERVICE MANUAL

YOU HAVE TO ADJUST THE BRAKE WHEN THE WHEELS ARE PROPERLY INFLATED (except solid tyre)



Loosen the bolt **A** of the clamp **B**.

If the bolt **A** is too hard to unscrew, it is advisable to spread some lubricant oil on it or heat it with a hot air blower.

Now you can slide the brake frontward/backward through the clamp and/or the clamp along the frame. At the same time, you can turn the clamp on the frame and the brake on the clamp.

Position the brake-knurled rod **C** at a distance **D** of a few millimetres and parallel to the ground.

Temporarily tighten the bolt **A** and try the brake out to check if the adjustment is good.

If necessary, repeat the same operation to reach the good adjustment.

A good adjustment has the brake not too hard to engage but braking, so you will have to find the suitable compromise.

Once reached the correct position, tighten the bolt **A**.

Carry out the same operation on the other side.

The adjustment for the sport brake is the same except for the distance **D**, in fact, the brake, in its resting position is far away from the tyre. Just make a few tries.





BRAKE SPACING

SERVICE MANUAL

In several cases, the distance between the tyre and the frame can be such as to make need moving the knurled rod **P** more external.

When originally assembling the wheelchair, such possible modification is already taken into account.

In case of a post-sale modification that results in the rear wheels being more external (from 0° to 2° or 4° camber; seat width enlargement; a different wheel), the brake may not work efficiently anymore, therefore, you will have to move the knurled rod. The brake is efficient if the knurled rod **P** is at least 5 mm beyond the tyre's mid-line.

In all cases, check the brake efficiency.

1) If the brake is fixed with a clamp, you just have to turn the clamp to the new position;

2) If the brake is fixed to the plate of support, you have to make the knurled rod longer by means of spacers.

Remove the bolt **B**. In order to remove it, put the knurled rod in a vice and heat it with a hot air blower because the bolt is locked with strong lock thread glue. **DO NOT FORCE WHEN UNSCREWING IT**, you may damage the bolt's head irremediably.

Once you have removed the bolt, the knurled rod comes off, too. Replace the bolt **B** according to the spacer **C** (7 or 11 mm) you will add. Put some strong lock thread glue on the bolt **B** and assemble the spacer **C** and the knurled rod **A**.

Put the knurled rod in a vice and tighten the bolt **B** hard.

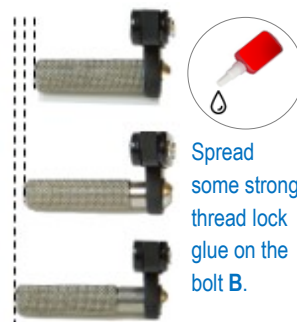
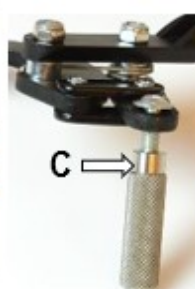
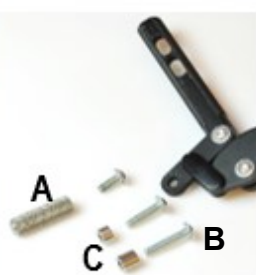
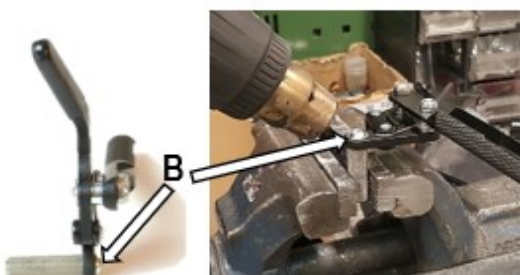
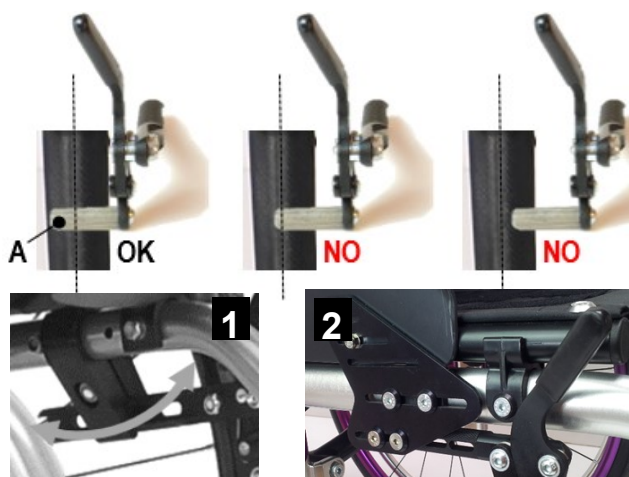

Spread some strong lock thread glue on the bolt **B**.

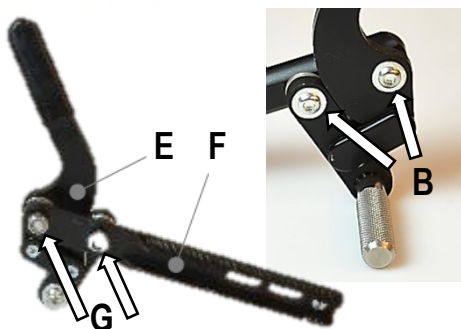

It is also possible to move the brake structure **E** from the adjustment rod **F**.

Remove the two nuts **G** and then the two bolts **B**.

Remove the spacers **H** around which the spring is assembled.

Observe how the spring is assembled because you will have to assemble it back later in the same way (you can always have a look at the other brake that is symmetric).

Insert the spacers **H** (H_1 = original; H_2 = 7 mm longer).

Position the spring and assemble the structure to the adjustment rod.

Start screwing the two bolts **B** all the way down and then the two nuts **G**.

Should the brake movement be hard, slightly loosen the bolts **B**.

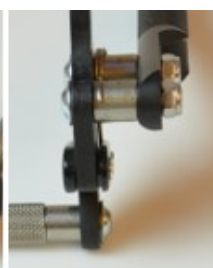



FOOTPLATE DISTANCE

SERVICE MANUAL

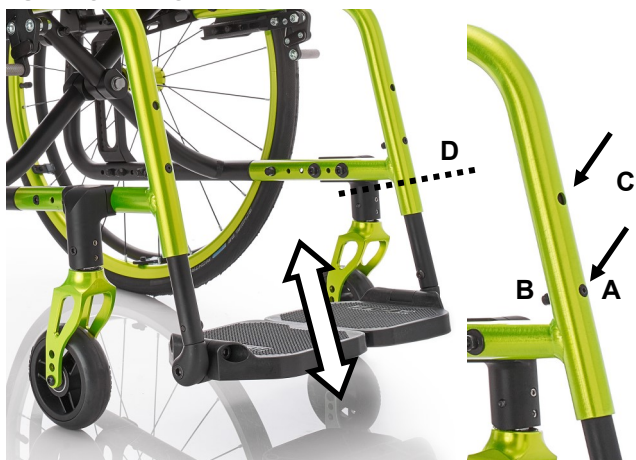

HEIGHT ADJUSTMENT EVERY 1.5cm

Remove the bolts **A** and their corresponding nuts and washers **B**.

Slide the footplate tube up or down until the necessary height.

Insert the bolts through the nearest holes and tighten.

Where present, it is possible to use the second hole **C**, too.

If necessary, you can adjust the height of the two independent footplates differently.

With one piece footplate, the two tube have, of course, to be adjusted at the same height.

The footplate tube can be either short (1) or long (2).

The short tube has two positionings for the adjustment support (RH and LH) in order to reach short footplate distances.

The long tube has only one positioning for the adjustment support and it is design for longer footplate distances.

The tubes for double footplates and one piece footplates are the same, but the adjustment support is different.

To reach the shortest footplate distance, one can, both at original assembly or afterwards, cut off both the footplate tube and the part of the frame just below the welding as shown by the dotted line **D** on the pictures at the top of the page.

It should be clear that the possible adjustment is then limited.

The adjustment support is fixed to the tube with the bolt **E** on which a drop of strong lock thread glue is spread. Should you need to change the position of the support (only short tube), in order to unscrew the bolt, you may need to heat it first. When you assemble the support, spread a drop of strong lock thread glue on it.

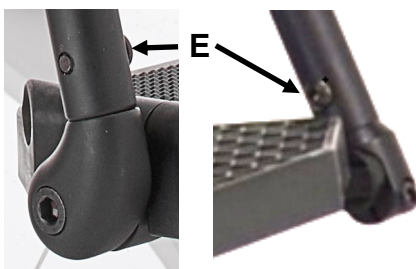

DOUBLE FOOTPLATE

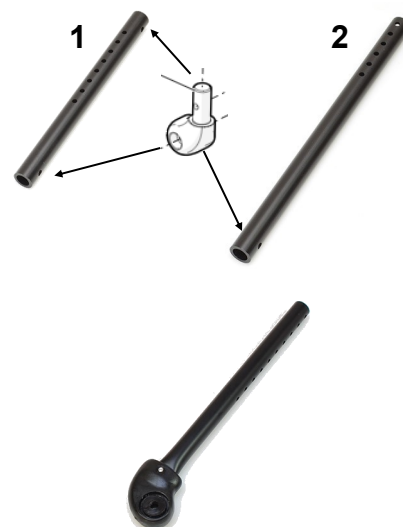

In the former version, the footplate tube (RH and LH) has only one length and the plastic adjustment support is integrated.

ONE PIECE FOOTPLATE

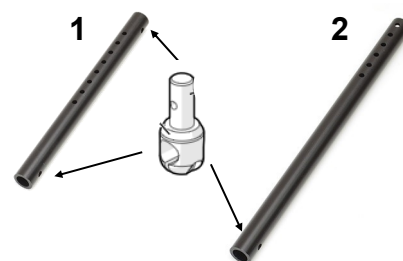

After adjustment, check that between the lower side of the footplate and the ground there is at least 2 cm and that there is no interference between footplate and casters.



DOUBLE FOOTPLATE

SERVICE MANUAL



ANGLE ADJUSTMENT

Loosen the bolt **A**.

Turn the plate clock or anti clock wise.

Once you find the correct inclination, tighten the bolt.

If necessary, you can adjust the inclination of the two independent footplates differently.

POSITIONING

2 positions: 2/3 internal or 2/3 external.

To reverse the position, remove the footplates complete with tubes and assemble right side to left and the other way round—see also chapter “height adjustment”. It may be necessary to adjust the angle.



FRICTIONING THE ROTATION

To adjust the friction of the footplate rotation movement, tighten or loosen the bolt **B** (the corresponding nut is held within it housing). Usually, when the footplate is lifted up the adjustment holds it in place.

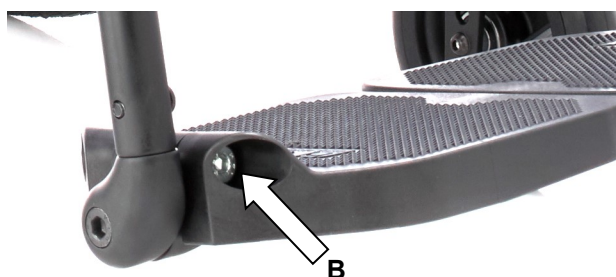

Particularity

Should you need a plate positioned 2/3 internal and the other 2/3 external, it is necessary to have two adjustment supports of the same side (two right or two left).

Note: for right hand side we intend right facing back, thus, if assembled on the left, it will be left facing front; for left hand side we intend left facing back, thus, if assembled on the right, it will be right facing front;

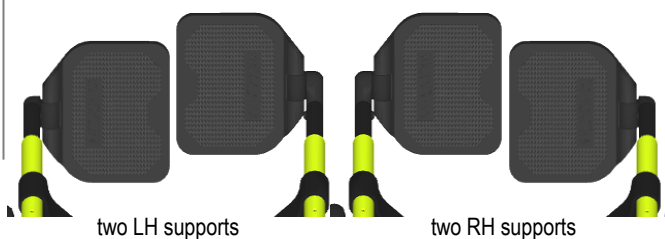



ONE PIECE FLIP-UP PLASTIC FOOTPLATE

SERVICE MANUAL



ANGLE ADJUSTMENT

Leave the footplate engaged in the using position.

Loosen the bolt **A** of both adjustment supports.

Turn the plate forward or backward.

Once reached the correct inclination, tighten the bolt **A** on the lock side.

Check the footplate engages and disengages easily (you may need to make a minor angle adjustment working on the plate) and then tighten the bolt **A** of the rotation side.

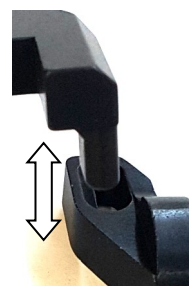

POSITIONING

4 positions: internal; 2/3 internal; 2/3 externa (not present in the order form); external

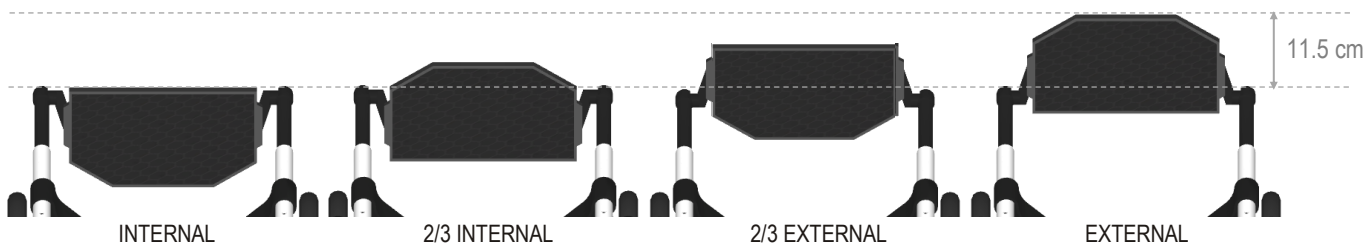

It is possible to change the footplate position in different ways

- 1) Loosen the angle adjustment bolts **A** and remove the lock side support and the rotation side support from the tubes and assemble them exchanging their position.
- 2) Remove the tubes following the instructions of the chapter footplate *distance* and assemble them again exchanging their position.

Finally, adjust the angle adjustment.

Using either of these two methods, you can turn the footplate position from internal to external (or vice versa) or from 2/3 internal to 2/3 external (or vice versa).

When reversing the footplate in either these two methods, you change the lock side, too.

Follows next page



ONE PIECE FLIP-UP PLASTIC FOOTPLATE

You can also change the position of the sole plate with respect to the structure under it that is fixed to.

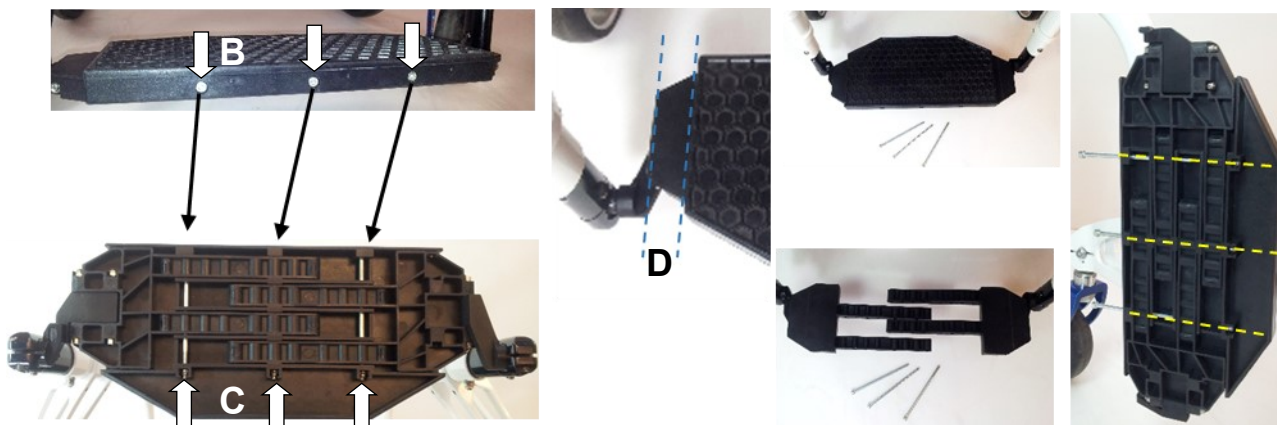

Remove the three bolts **B**. To hold the nuts **C** no spanner is needed.

Observe the distance **D** that you will have to keep after changing position. It is useful to mark it or measure it in order to have a reference.

Remove the plate. You will see the two parts of the lower structure free.

Position the plate in the opposite side on the lower structure and align the holes of all components.

Make sure to keep the same distance **D** at right and left and equal to the reference you took earlier.

Insert the bolts **B** and the nuts **C** and tighten until compacting the parts (tightening hard is not necessary).

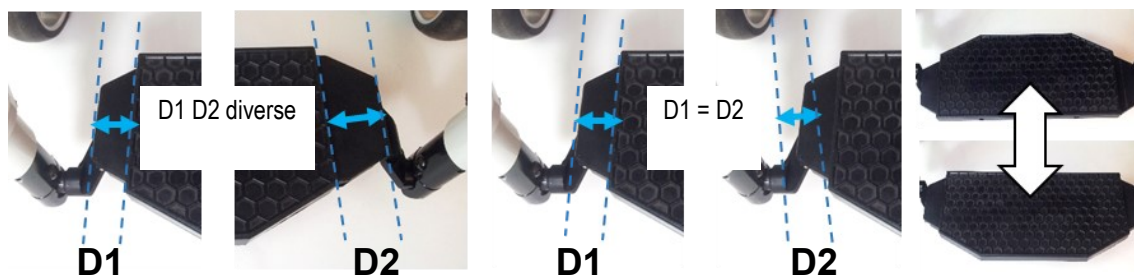

When reversing the sole plate, you can turn the footplate position from internal to 2/3 internal (or vice versa) or from external to 2/3 external (or vice versa).

The lock side remains the same.

To adjust the friction of the footplate rotation movement, tighten or loosen the bolt **E**.

It may be necessary to hold the nut **F** with a wrench.

Usually, when the footplate is lifted up the adjustment holds its position.

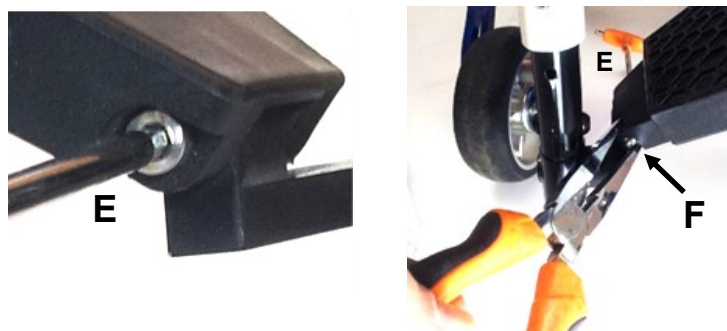



ONE PIECE FLIP-UP ALUMINUM FOOTPLATE

SERVICE MANUAL



ANGLE ADJUSTMENT

Leave the footplate engaged in the using position.

Loosen the bolt **A** of both adjustment supports.

Turn the plate forward or backward.

Once reached the correct inclination, tighten the bolt **A** on the lock side.

Check the footplate engages and disengages easily (you may need to make a minor angle adjustment working on the plate) and then tighten the bolt **A** of the rotation side.

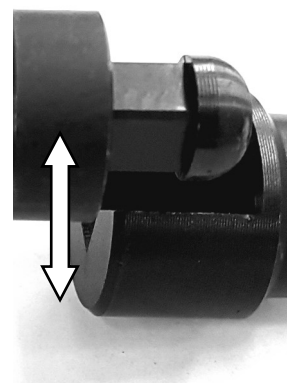

POSITIONING

4 positions: internal; 2/3 internal; 2/3 externa; external

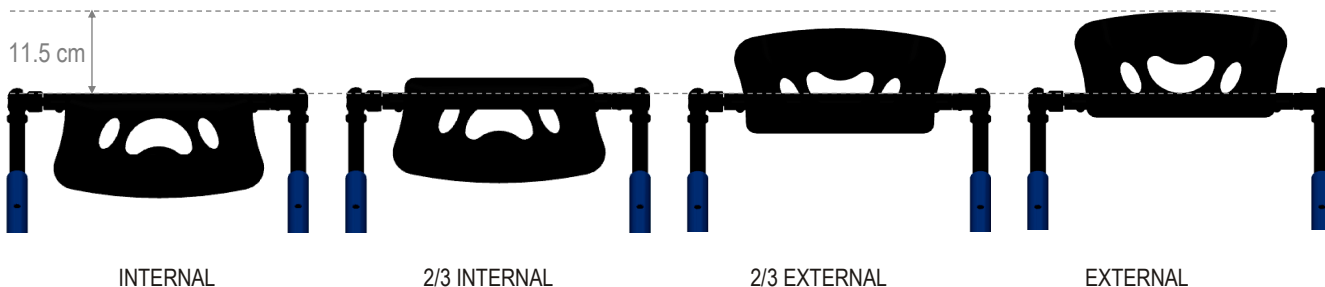

CHANGING THE PLATE POSITION

Remove the 4 bolts **B** and fix the plate using the other set of holes.

The plate can be orientated with its curved side facing either back or front.



Follows next page



ONE PIECE FLIP-UP ALUMINUM FOOTPLATE



REVERSING THE FOOTPLATE

- 1) Loosen the angle adjustment bolts **A** and slide off the lock and rotation sides supports from the tube and assemble them reversing their position.
- 2) Or, remove the tubes, follow instructions of chapter *footplate distance* and assemble them reversing their side.

Finally, adjust the inclination and tighten the bolts **A**— see also “*angle adjustment*”.
Using either of these two methods, you can turn the footplate position from internal to external (or vice versa) or from 2/3 internal to 2/3 external (or vice versa).
When reversing the footplate in either these two methods, you change the lock side, too.

CHANGING THE LOCK SIDE WHILE KEEPING THE SAME PLATE POSITION

Reverse the footplate position as above indicated on point 1 of the chapter “*reversing the footplate*”.
The footplate tubular is fixed to the rotation support and to the lock support with two bolts **C** each.
Lift the footplate.
Remove the two bolts **C** of the lock support and slide it off the footplate tubular.
Remove the two bolts **C** of the rotation support and slide the footplate out of it.
Should the bolts be too hard to unscrew, you will have to heat them up in order to make the thread lock glue lose its efficiency.
Spread some mild or strong thread lock glue on the bolts **C**.
Insert the lock and rotation supports on the footplate tubular opposite and fix them with the bolts **C**.
Pay attention when fixing the rotation support, in fact, it can rotate on one direction only (if it is mounted opposite, the footplate can only rotate downward).
Adjust the inclination and tighten the bolts **A**— see also “*angle adjustment*”.

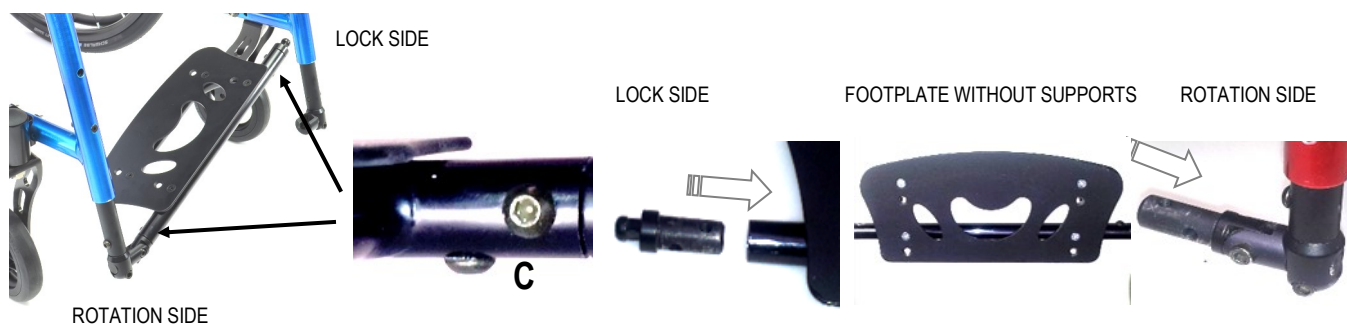

FRICIONING THE ROTATION

To adjust the friction of the footplate rotation movement, tighten or loosen the bolt **D**.

It is advisable to remove the bolt, squeeze a little part of its thread with a long nose pliers, spread a drop of strong thread lock glue, insert it and screw it. In fact, the movement of the footplate can lead that bolt to unscrew itself. Usually, when the footplate is lifted up the adjustment holds it in place.

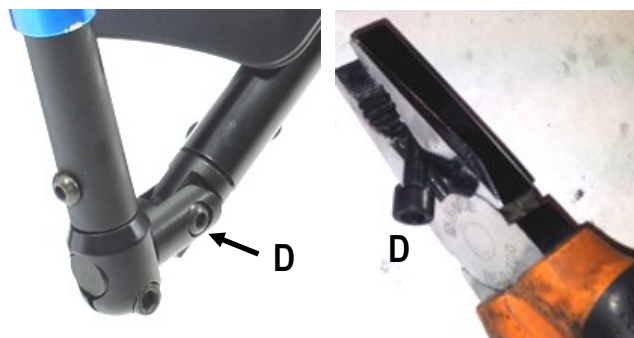



ONE PIECE FLIP-UP CARBON FOOTPLATE

SERVICE MANUAL

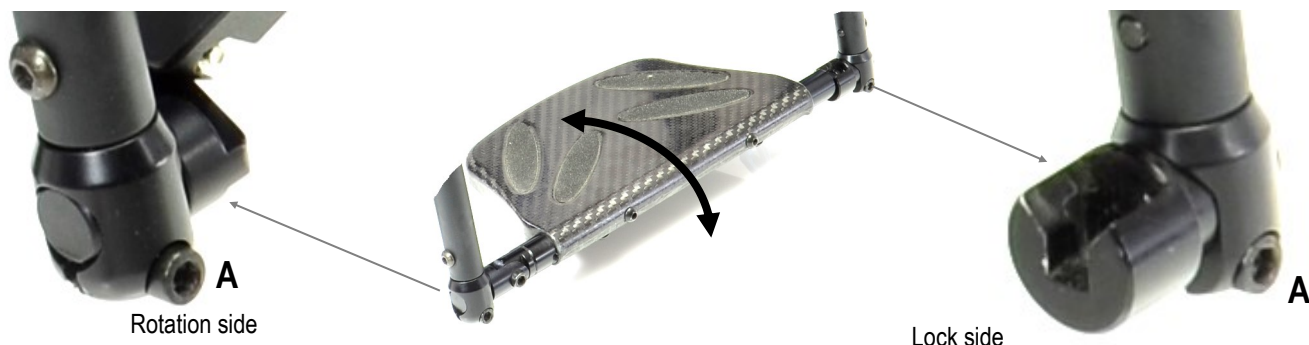

ANGLE ADJUSTMENT

Leave the footplate engaged in the using position.

Loosen the bolt **A** of both adjustment supports.

Turn the plate forward or backward.

Once reached the correct inclination, tighten the bolt **A** on the lock side.

Check the footplate engages and disengages easily (you may need to make a minor angle adjustment working on the plate) and then tighten the bolt **A** of the rotation side.

Note: this kind of footplate allows for the plate to be turned 180°, therefore, before proceeding with the adjustment, raise the plate from the lock side and turn it until its rotation stops.

This rotation allows for a temporary opposite position of the plate, but it also helps to reduce the encumbrance if the plate, in its normal use, is positioned “external”.

To carry out such operation, just raise the plate from the lock support and turn it to the opposite position; then engage it to the lock support normally.

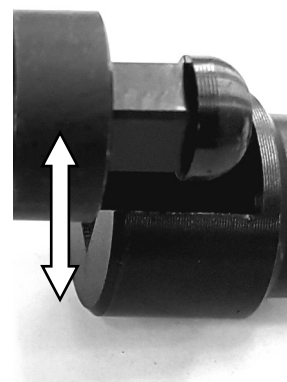

POSITIONING

2 positions: internal; external

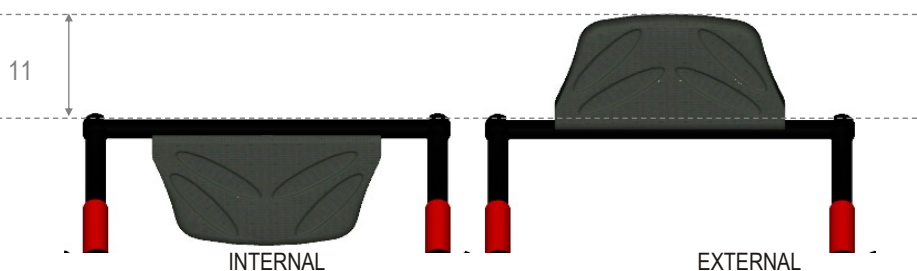

REVERSING THE FOOTPLATE

1) Loosen the angle adjustment bolts **A** and slide off the lock and rotation sides supports from the tube and assemble them reversing their position.

2) Or, remove the tubes, follow instructions of chapter *footplate distance* and assemble them reversing their side.

Finally, adjust the inclination and tighten the bolts **A**— see also “*angle adjustment*”.

When reversing the footplate in either these two methods, you change the lock side, too.

Follows next page



ONE PIECE FLIP-UP CARBON FOOTPLATE

SERVICE MA-

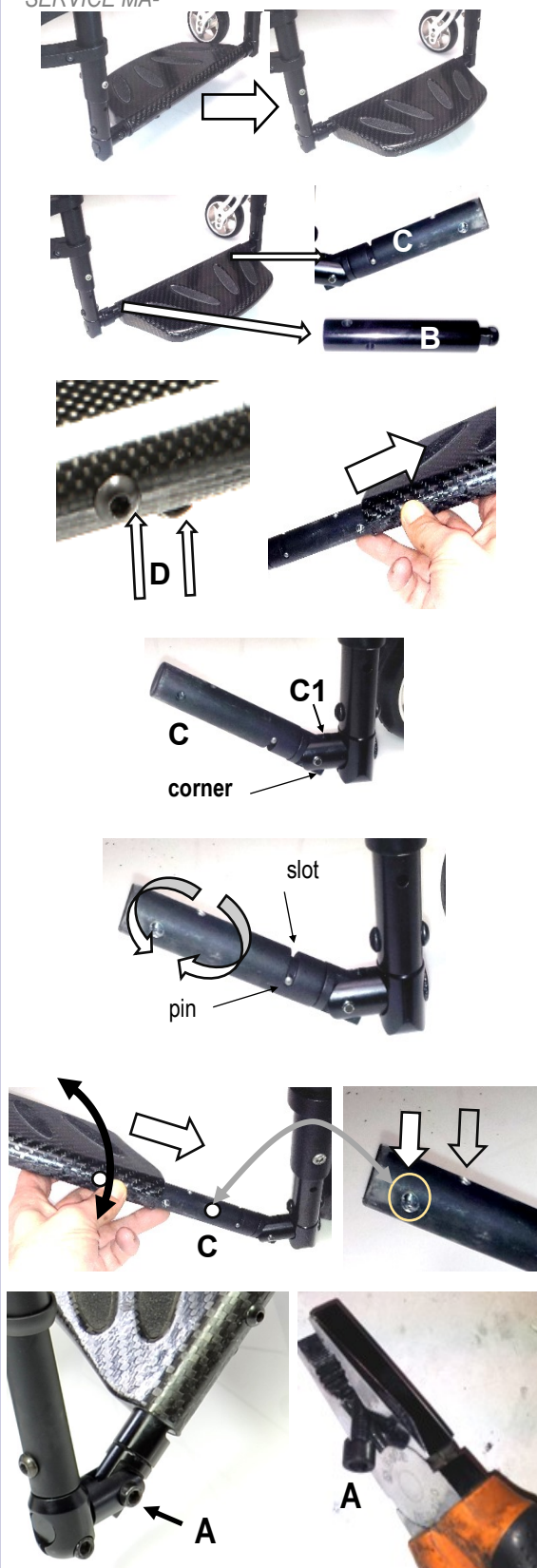

CHANGING THE LOCK SIDE WHILE KEEPING THE SAME PLATE POSITION

Reverse the footplate position as above indicated on point 1 of the chapter “reversing the footplate”.

The footplate is fixed with the rotation tube **B** and the lock tube **C** with two bolts **D** each.

Lift the footplate.

Remove the 2 bolts **D** on the lock side **B** and slide the support off the footplate.

Remove the 2 bolts **D** on the rotation side **C** and slide the footplate off.

Should the bolts be too hard to unscrew, you will have to heat them up in order to make the thread lock glue lose its efficiency.

Spread some strong thread lock glue on the bolts **D**.

Insert the lock tube **C** into the other side of the footplate and fix the bolts **D**.

Assemble the rotation tube to the support **C1** so that the rotation of is upward (the corner of the extremity of the tube must be assembled at the bottom).

The tube **C** is made in two parts fixed together by means of a cylindrical pin that also works as full stroke of the 180° rotation along the slot.

The correct fixing of the footplate to the tube **C** has to allow the footplate, after lifting it up, to rotate front and backward moving upward.

Partly insert the footplate onto the tube **C** and align the front hole of the footplate and the external hole of the tube **C**.

Holding the two parts, check that the rotation is upward. If the rotation is downward, hold the footplate and turn only the tube **C** by 180°. Check the rotation again.

Spread some mild or strong thread lock glue on the bolts **D**.

Likewise, insert the footplate along the tube **B** making the hole coincide. Then fix the two bolts **D**.

Adjust the footplate inclination following the instruction of the chapter “angle adjustment”.

FRICIONING THE ROTATION

To adjust the friction of the footplate rotation movement, tighten or loosen the bolt **A**.

It is advisable to remove the bolt, squeeze a little part of its thread with a wrench, spread a drop of strong thread lock glue, insert it and screw it. In fact, the movement of the footplate can lead that bolt to unscrew itself. Usually, when the footplate is lifted up the adjustment holds it in place.



SERVICE MANUAL

ONE PIECE PLASTIC FOOTPLATE WITH AUTOMATIC CLOSURE



ANGLE ADJUSTMENT

Loosen the bolt **A** of both adjustment supports.

Turn the plate forward or backward.

Once reached the correct inclination, tighten the bolt **A** on one of the two sides.

Check that the moving side of the plate evenly leans on the lower support.

To do so, with a finger in the middle of its extremity, gently press the plate down and check how it leans over the support.

If it is even, the adjustment is correct.

Should it lean on one side first, the footplate will work under more stress, therefore it will be necessary to correct the adjustment on the side that is still not tightened. Finally, tighten the bolt **A** of this side, too.

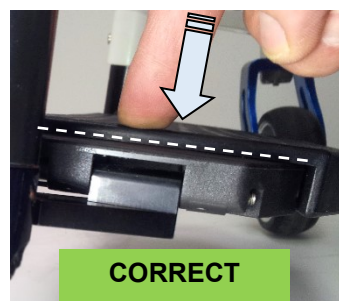
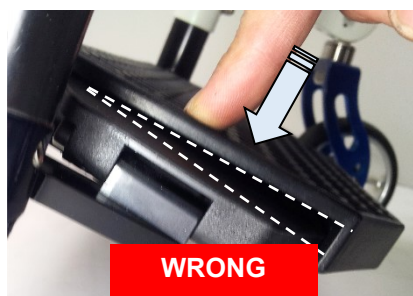

POSITIONING

4 positions: internal; 2/3 internal; 2/3 external (not present in the order form); external

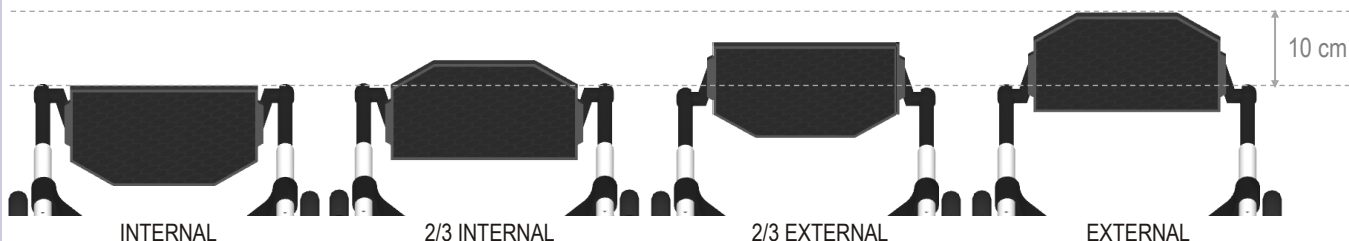

Follows next page



ONE PIECE PLASTIC FOOTPLATE WITH AUTOMATIC CLOSURE

SERVICE MANUAL



REVERSING THE FOOTPLATE

- 1) Loosen the angle adjustment bolts **A** and slide off the lock and rotation sides supports from the tube and assemble them reversing their position.
- 2) Or, remove the tubes, follow instructions of chapter *footplate distance* and assemble them reversing their side.

Finally, adjust the inclination and tighten the bolts **A**— see also “*angle adjustment*”.

Using either of these two methods, you can turn the footplate position from internal to external (or vice versa) or from 2/3 internal to 2/3 external (or vice versa).

When reversing the footplate in either these two methods, you change the lock side, too.

You can also change the position of the footplate with respect to the rotation supports **B**.

Remove the bolt **C** of both supports. Usually, to hold the nut **C** no tool is needed, but if it turns, you can hold it using a long nose pliers.

Assemble the footplate reversing its position on the supports **B**.

Pay attention to the correct housing for the nut **D**.

This way, you can turn the footplate position from internal to 2/3 internal (or vice versa) or from external to 2/3 external (or vice versa).

Do not tighten the bolt **D** hard, in fact, it has to allow an easy

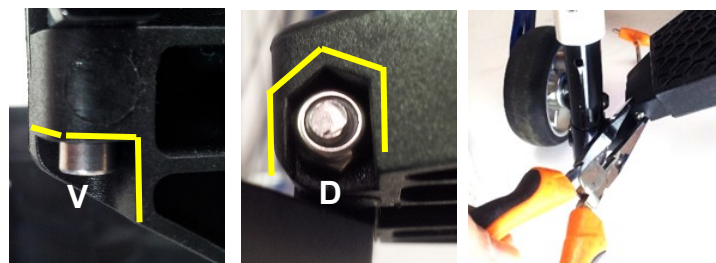
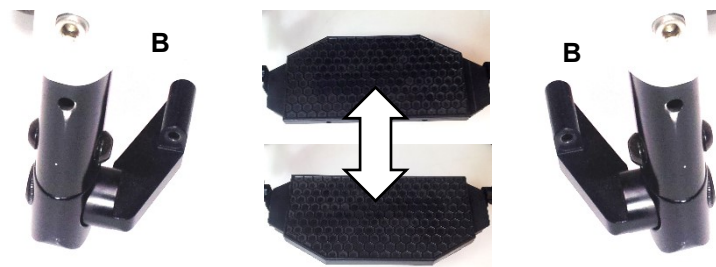



SERVICE MANUAL

ONE PIECE ALUMINIUM FOOTPLATE WITH AUTOMATIC CLOSURE (COMPACT)



ANGLE ADJUSTMENT

Loosen the bolt **A** of both adjustment supports.

Turn the plate forward or backward.

Once reached the correct inclination, tighten the bolt **A** on one of the two sides.

Check the footplate folds and unfolds automatically when opening or closing the seat (you may need to make a minor adjustment working on the plate) and then fix the bolt **A** of the other side.

POSITIONING

2 positions: internal; external



REVERSING THE FOOTPLATE

1) Loosen the angle adjustment bolts **A** and slide off the lock and rotation sides supports from the tube and assemble them reversing their position.

2) Or, remove the tubes, follow instructions of chapter *footplate distance* and assemble them reversing their side.

Finally, adjust the inclination and tighten the bolts **A**— see also “*angle adjustment*”.

IF THE FOOTPLATE DOES NOT FOLD AUTOMATICALLY

The angle adjustment of the two supports is different: adjust one of the two supports (see “*angle adjustment*”).

The friction of rotation of one or both supports is excessive: loosen the bolt **B**.

The parts involved in the rotation are dirty: screw off the bolt **B** to remove the footrest plate from the support; clean the parts, re-assemble the plate on the support and tighten the bolt **B** making sure the rotation is free, but with a minimum play.

To prevent the bolt **B** from loosening accidentally, it is advisable to squeeze a little part of its thread with a wrench, spread a drop of strong thread lock glue, insert it and screw it.

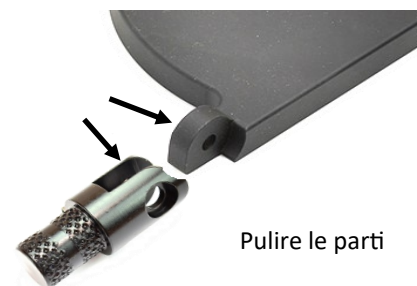
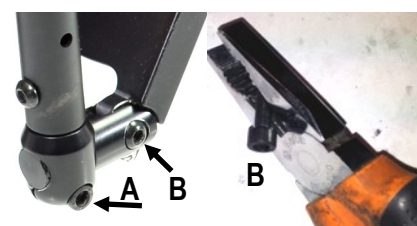

Pulire le parti



SERVICE MANUAL

BACKREST HEIGHT

Standard rear frame



Remove the backrest upholstery.
If side guards are present, partly fold the crossbar and remove the bolt/washer/nut **A**. Move the rear wheel off by 2-3 cm without removing it.

Turn the side guard up backward. Slide the backrest band along the frame until you get access to the bolt/washer/nut **B**. Remove bolt/washer/nut **B**. Raise or lower the backrest height to the wished position. Fix the bolt/washer/nut **B**.

When both rear height and backrest height are very low, one or two bolts/washers/nuts **C** that fix the rear wheel plate, can also fix the backrest tube.

If the backrest tube is already fixed with one or two bolts/washers/nuts **C**, remove such bolts, position the backrest to the wished height and fix it with the bolt/washer/nut **B**. Finally, fix the rear wheel plate.

If the backrest tube, when lowering it, stops against the bolt/washer/nut **V** before reaching the wished height, remove the bolts **C**, position the backrest tube at the wished height and fix it with the bolt/washer/nut **B**. Then, through the holes of the rear wheel plate and, consequently, through the tube's holes, pass a 6 mm drill pin. Finally, fix the rear wheel plate.

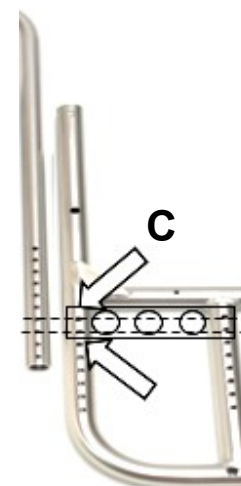

For this rear frame, the tubes are available in two sizes that allow for different height.

Usually, the backrest tube is fixed through the hole **F1** that allows for backrest height from 28.5 to 42 cm (short tube) or from 40.5 to 54 cm (long tube).

If you lower the tube over the last hole, you can fix it with the bolts **C** (that may fix the rear wheel plate, too). In such case, you have to widen the hole to 6 mm. The minimum height you can reach is 25 cm (with long tube, you have to cut it off 10 cm approx.).

To have higher heights, you can fix the tubes through the hole **F2** as long as you leave at least 8 cm of tube below the fixing point.

To reduce possible play and possible noise, you can put some sticky tape around the backrest tube at its bottom and at just above the last hole.





BACKREST HEIGHT

Dynamic (first version) and Dynamic 2.0 rear frame

SERVICE MANUAL



Dynamic 2.0

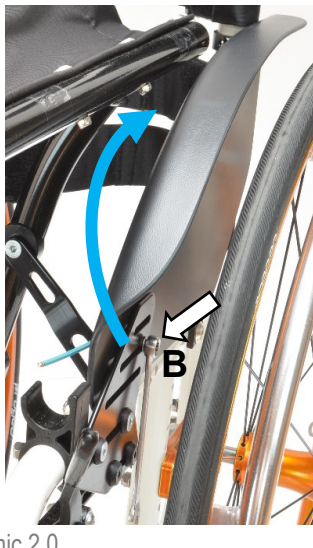

Dynamic

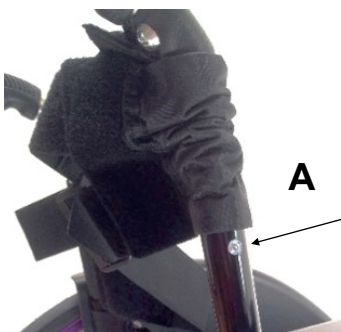

A

Remove the backrest upholstery and slide up the protecting sleeves of the backrest bands along the tube until the fixing screw A is accessible.

If it was not accessible:

- Dynamic 2.0 rear frame, partly fold the crossbar, remove the bolt/washer/nut B and turn the side guard backward;
- Dynamic rear frame, loosen the two headless bolts C and the nut that fixes the axle P (see also "side guard adjustment with rotative system") and turn the side guard forward as much as necessary.

Remove bolt/washer/nut A.

Raise or lower the backrest tubes to the desired height.

If the minimum height you can reach is not enough, it is necessary to cut the lower side of the tube.

If the maximum height you can reach is not enough, it is necessary to change the tube.

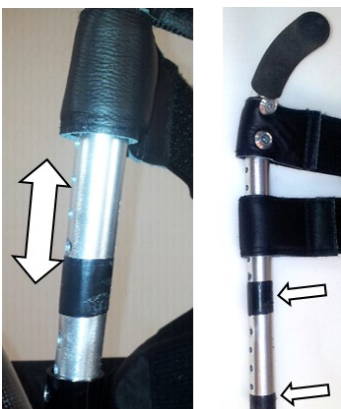

Warning: to guarantee a good stability, between the fixing hole and the lower side of the tube, there should be at least 4 cm. If the tube is cut, the lower hole will be only a few millimetres from the end of the tube; therefore, you should not use that hole, the next and, sometimes even the third to fix the backrest height.

Replace the screws and tighten.

Finally:

- Dynamic 2.0 rear frame, fix the side guard with the bolt/washer/nut B;
- Dynamic rear frame, turn the side guard to the correct position and then tighten the nut that fixes the axle P and the two headless bolts C.

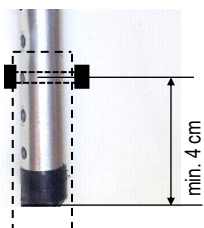

min. 4 cm

To reduce possible play and possible noise, you can put some sticky tape around the inner tube at its bottom and at its fixing point (or just under it).



SERVICE MANUAL

BACKREST ANGLE

Dynamic (first version) and Dynamic 2.0 rear frame

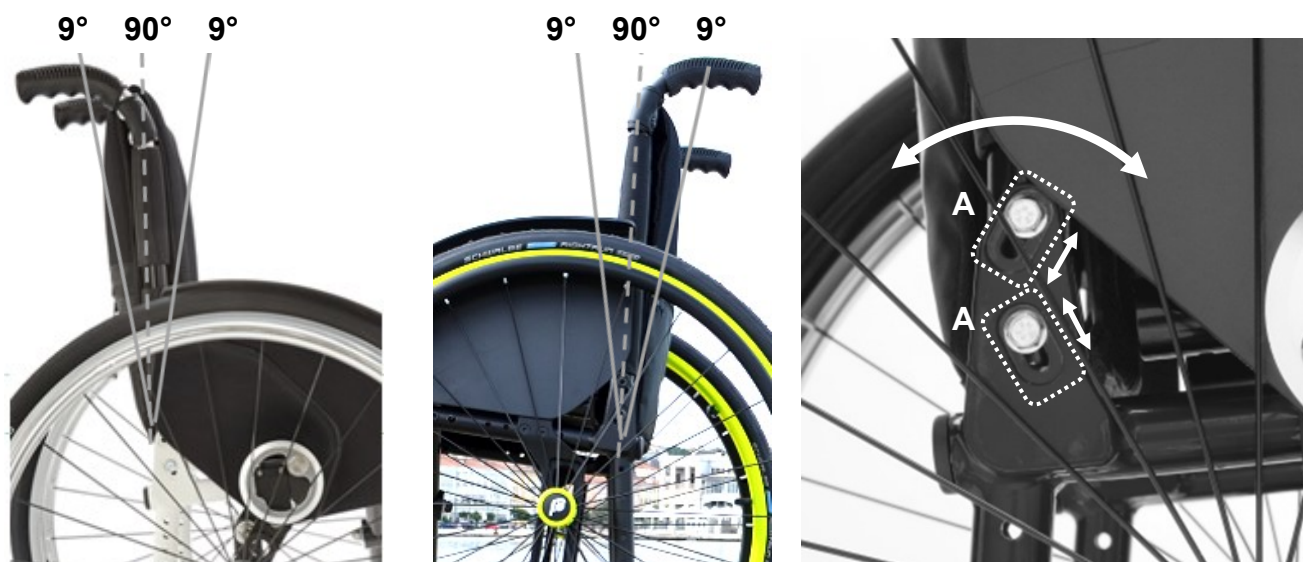

Adjustment from 9° open (tilted backward) to 9° close (tilted forward) with respect to 90° to the seat.

The backrest tube is fixed with 4 bolts **A**, two on the outer side and two on the inner side of the wheelchair. To adjust the angle, loosen the 4 bolts and swing the tube forward or backward to the desired inclination. Finally, tighten the 4 bolts **A**.

In some case, the closest backrest angle may create interference between the backrest tubes and the seat tubes when folding the wheelchair.

Should that happen, open the backrest angle the strictly necessary.

Remember that the backrest angle affects the point of balance of the wheelchair.

In fact, if tilted backward (open angle) the wheelchair becomes less stable.



It is advisable to spread a drop of mild lock thread glue on the bolts **A**.



QUICK RELEASE AXLE

(rear wheel)

SERVICE MANUAL

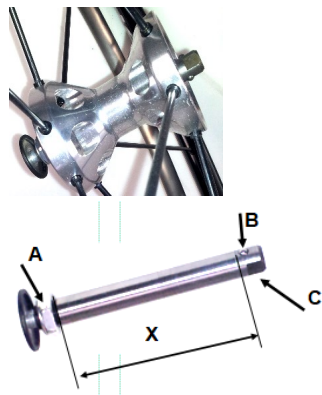

Adjust the quick release axle so that the rear wheel is safely fixed with no risk that it comes off accidentally.

At the same time, there should be no or very little play.

To check if the rear wheel is safely fixed, take hold of the hub without pressing the release button, and try to pull the wheel in and out.

As regular maintenance, it is advisable to clean the quick release axle and spread a little of grease on it.

If the wheel comes off, the distance **X** between the nut **A** and the balls **B** is too short, therefore, it is necessary to unscrew the nut **A** while holding the point **C** of the axle. **If there is play**, the distance **X** between the nut **A** and the balls **B** is too long, therefore, it is necessary to screw the nut **A** while holding the point **C** of the axle

In both cases, make a few tries until the correct adjustment. There is no need to remove the axle from the wheel.



It may happen that you adjust the axle so that the wheel only seems properly fixed, but it is not safe.

In fact, to check the adjustment, you have also to try to press the button just a little bit (as guidance, $\frac{1}{4}$ of its run) and pull the wheel. If it comes off, it means that it may come off while driving! Therefore, this is a very important **safety check**.

If the wheels comes off, unscrew the nut a little bit until you have the proper adjustment.

If the wheel (the axle) gets stuck in the receiver, you can proceed in two ways:

- press the quick release button, pull the rear wheel and, at the same time, with a mallet, gently hit (a little harder if necessary) the hub or spokes of the wheel.
- press the quick release button so that the axle's pin is out, then position a spanner on the axle's shaft and around the pin. Now, while pushing the axle's button, pull the rear wheel and gently hit the spanner. To do that, you need the help of another person.

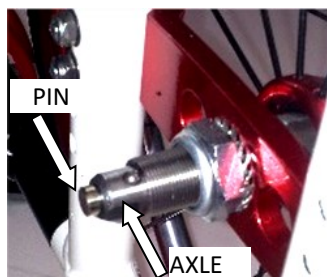

The reasons why the wheel can get stuck can be two.

- the receiver is slightly damaged; in this case, with a $\frac{1}{2}$ reamer, re-pass the receiver's hole.
- when pushing the axle's button, the balls do not fall inside the axle's shaft; first, clean the axle, then try to push the button a few times to see if you have solved the problem; if not, press the button, hold the axle's pin with a wrench and unscrew the button half of a turn. Check and if necessary do the same with another half turn. Do not unscrew the button too much: the pin will come off and, consequently, the balls will fall to the ground.





SEAT WIDTH ENLARGEMENT

Standard and Dynamic 2.0 rear frame

SERVICE MANUAL

It is possible to make the seat width larger by maximum 10 mm each side, by modifying the side guard fixing.
The Standard and Dynamic 2.0 uses the same system for fixing the side guards. The pictures refer to Standard frame.

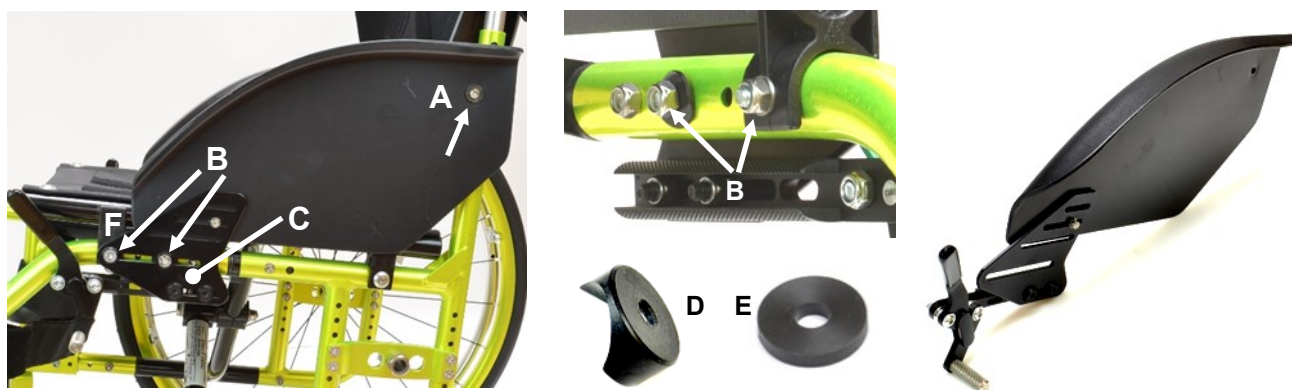

Remove bolt/washer **A**.

Remove bolts/washers/nuts **B** that fix the plate **C**.

Now, the side guard is still fixed to the plate, but it is not necessary to remove it (it may turn but not slide). Even the brake is still fixed, but you do not need to remove it.

Pay attention to the half-moon spacers **D** and, if already present, the spacers **E** between the plate **C** and the frame.

Note: one bolt **B**, as in these pictures, may use as spacer the crossbar's seat tube support **F**.

The bolts **A** and **B** have to be replaced with 5 or 10 mm longer ones according to the wished enlargement.



Insert longer bolt and washer **A** on the side guard and add one or two 5 mm spacers **E**.

Screw the bolt in the adjustment ring **G** without tightening because you will later need it to slide.

Insert the longer bolts **B** through the slot of the plate, add one or two 5 mm spacers **E** on each bolt and also the half-moon spacer **D**.

Align the slot with the fixing holes on the frame and let the bolts through them.

Put washer and nuts and screw them without tightening because you will later need a little adjustment.

During this step, the rear fixing of the side guard is free to slide.

Follows next page



SEAT WIDTH ENLARGEMENT

Standard and Dynamic 2.0 rear frame

SERVICE MANUAL

Put the rear wheel on and position the side guard as it was before removing the parts (you can have a look at the side guard on the other side of the wheelchair).



Tighten the plate **C** with the bolts **B**. If one was not accessible, remove the rear wheel, fix the second bolt **B** and screw the bolt **A** just enough to be able to vertically slide the side guard, but also to let it hold its position.

When all bolts are accessible even with the rear wheel on, operations result quicker. These instructions do not consider this convenient case.

Put the rear wheel on and vertically slide the side guard to the correct position.

Remove the wheel and tighten the bolt **A**.

Tighten the two bolts/washers/nuts **B**.

Now, it is necessary to check the gap between side guard and rear wheel and decide whether or not, to add spacer on the wheel receiver. In such case, remove the wheel receiver and add 3 and/or 6 mm spacers.

Advice: before removing the receiver, it is useful, as a try, put the spacer on the axle of the wheel and put it on. This way, you will immediately see what spacer you need.

Check and, if necessary, adjust the brakes.

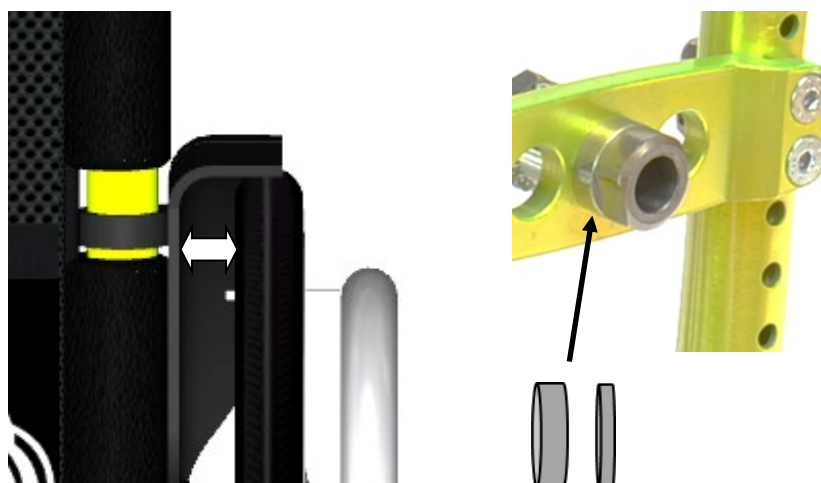



FOOTPLATE FRAME LOCKING POSITION

(only for Exelle Vario)

SERVICE MANUAL

The swing-away and removable "VARIO" frame has the characteristic of locking to a steel ring **A**. Such ring is fixed to the frame by means of three headless bolts: **B1 B2** in front and **B3** at rear. The fixing point **C**, thus, is not one only, but, indeed, it is variable in rotation.

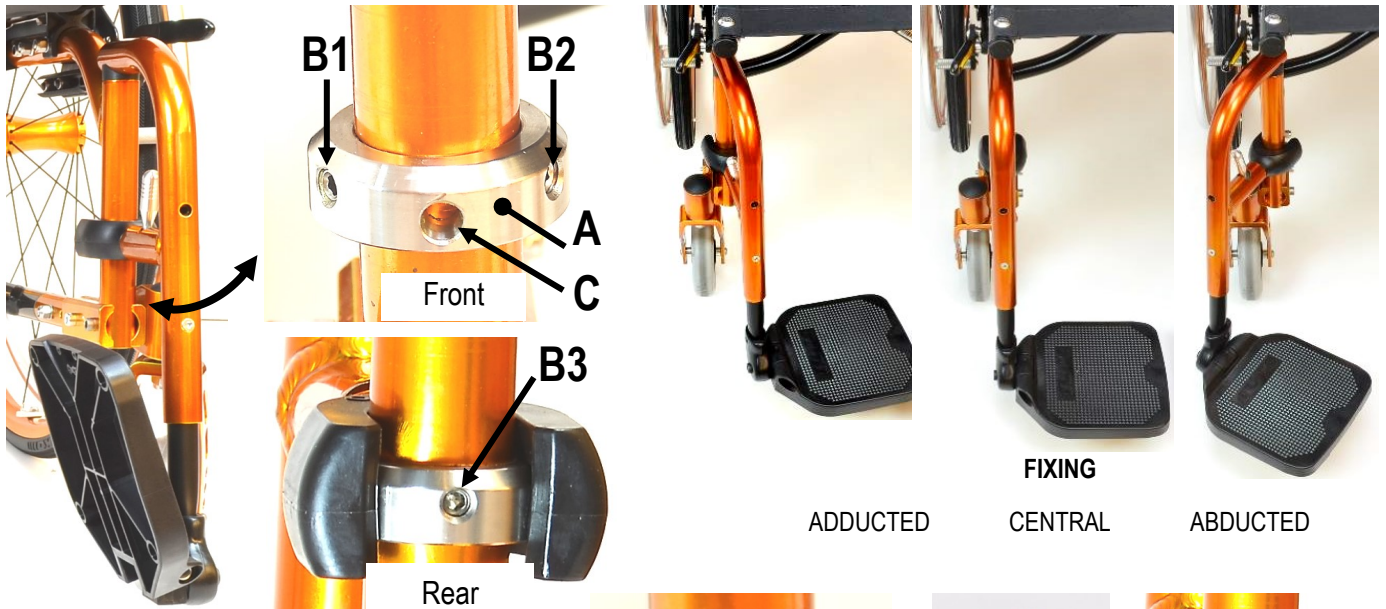

Remove the footplate.
Remove the front headless bolts **B1** and **B2**.
Put the footplate on and lock it.
Loosen the headless bolt **B3**.
Now, turn the footplate until you need it.
Screw and tighten the headless bolt **B3**.
Remove the footplate (or turn it until getting access to one headless bolt **B1** or **B2** first and then the other).
Insert and screw the headless bolts **B1** and **B2** all the way down without tightening them.
Now tighten the two headless bolts.
Put the footplate on and lock it.

At origin, we assemble the wheelchair with central fixing point.

You can change the fixing point at any time as long as the footplate is "double footplate".

The footrest plate is not designed to be turned for compensation.

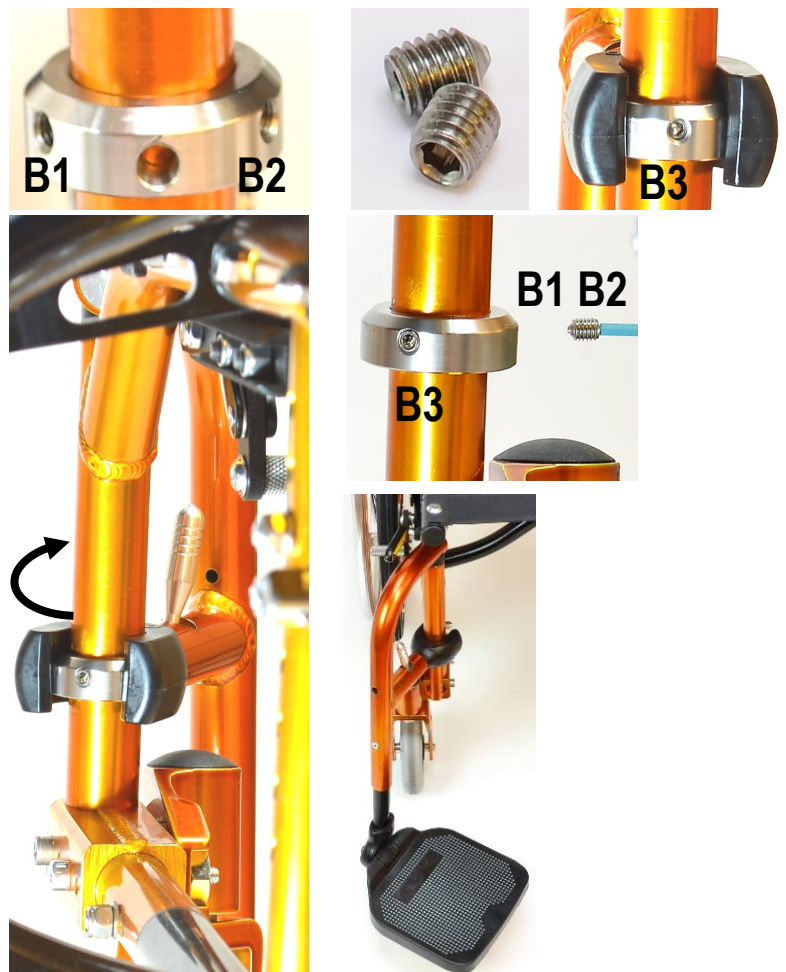

It is advisable to spread a drop of mild lock thread glue on the headless bolts **B**.