



SERVICE MANUAL

ENGLISH



SERVICE MANUAL JOKER

JOKER CARBON

Rev. 2 - 2021/05



JOKER



JOKER CARBON





JOKER

JOKER CARBON

GENERAL WARNINGS

ANY ADJUSTMENT CAN BE CARRIED OUT EXCLUSIVELY BY QUALIFIED AND AUTHORIZED BY REHATEAM® S.R.L. PERSONNEL.

It is forbidden to carry out any modifications, even when possible, to the original design.

Any adjustments and/or any modification that is carried out by non-authorized personnel will immediately void the warranty on the product and it relieves Rehateam s.r.l. from any responsibility on any malfunctioning and/or damage due to such adjustments/modifications.

Always contact Rehateam s.r.l. and its technicians for any non-standard requirements or modifications to allow them to evaluate such modifications and verify that they will not compromise the normal and safe use of the wheelchair.

Any modification of the original parameters and set up could seriously compromise the safe operation of the wheelchair causing damage to both the user and the wheelchair itself.

After every adjustment made to the wheelchair, check carefully that all parts are correctly fixed. Check that all screws and nuts are tightened and that all moving parts are functioning correctly.

After any adjustment, always test the wheelchair before giving the product to user and/or his/her attendant.

Rehateam s.r.l. disclaims any responsibility for damage to the product, to any object or to people due to any modification that is not properly performed or that, in any case, does not guarantee safety to the user.



SERVICE MANUAL

JOKER

JOKER CARBON

Page	adjustment
04	FRONT HEIGHT 1 Caster on fork
05	FRONT HEIGHT 2 Sliding the fork support
06	FORK ANGLE 1 System with spirit level
09	FORK ANGLE 2 Fork support V-Design
10	FORK ANGLE 3 Fork support V-Design 2.0
11	FORK ANGLE 4 JOKER CARBON
12	DIRECTIONALITY
15	REAR HEIGHT
16	SETTING (point of balance)
17	CAMBER AND CONVERGENCY
19	BRAKE
20	BRAKE SPACING
21	FOOTPLATE DISTANCE FOR 7° FRAME
22	FOOTPLATE DISTANCE JOKER CARBON
23	ALUMINIUM FOOTPLATE for 7° frame
24	CARBON FIBRE FOOTPLATE for 7° frame
25	ALUMINIUM FOOTPLATE WITH CURVED TUBES for 7° frame
26	FIXED CARBON FIBRE FOOTPLATE for 7° frame
27	FOOTPLATE DISTANCE FOR “ZERO” FRAME
28	FRONT FRAME RIGIDIZER for Joker “zero”
29	DOUBLE FOOTPLATE for Joker “zero”
30	ONE PIECE FLIP-UP ALUMINIUM FOOTPLATE for Joker “zero”
32	ONE PIECE FLIP-UP CARBON FOOTPLATE for Joker “zero”
34	BACKREST HEIGHT Aluminium or titanium backrest
35	BACKREST HEIGHT Carbon fibre backrest
36	BACKREST ANGLE
37	QUICK RELEASE AXLE (rear wheel)



SERVICE MANUAL

FRONT HEIGHT 1

(caster on fork)

Versione with
V-design support



Fork
height

Holes intervals – 12,7 mm

Sport – 2 holes – h. 88

Small – 3 holes – h. 112

Versione with Integrated bearings



Fork
height

Holes intervals – 12,7 mm

Sport – 2 holes – h. 100

Small – 3 holes – h. 115

Intermediate – 4 holes – h. 145

Medium – 5 holes – h. 170

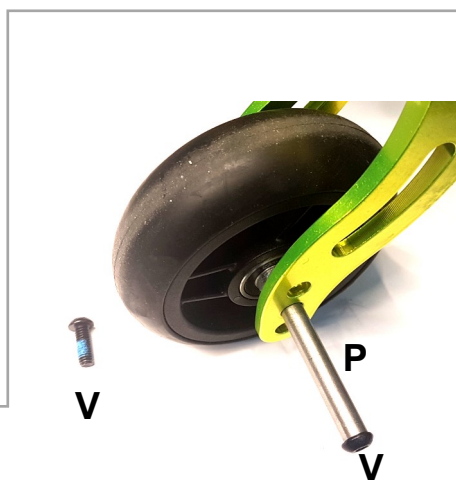

The entity of the adjustment obviously depends on the caster and fork's sizes.

Screw off the bolt **V** while holding the other.

Remove the axle **P**.

Position the caster to another hole, insert the axle and fix the bolt **V** holding the one on the other side.

Pay attention to the spacers between caster and fork.

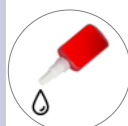

It is advisable to spread a drop of mild lock thread glue on the bolts **V**.



FRONT HEIGHT 2

Sliding the fork support

(not for version with swing away footplates)

SERVICE MANUAL

All the following fork supports are fixed to the frame with clamp system.

Once you loose the clamp, you can slide the support along the frame and change the front height.



SUPPORT WITH SPIRIT LEVEL

V-DESIGN SUPPORT

V-DESIGN 2.0 SUPPORT

Support with Spirit Level

Loosen the headless bolt **C** and the two nuts **B**. Slide the support upward or downward to the desired height.

Check that the two bolts **A** are fully tightened. There must not be any room between clamp and plate. Fix the two nuts **D** holding the bolt **A** and screw the headless bolt **G**.

Repeat the same operations on the other side making sure the height is the same. The two front wheels must be touching the ground.

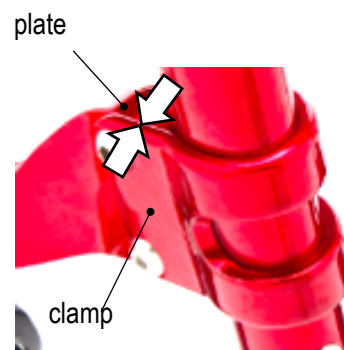
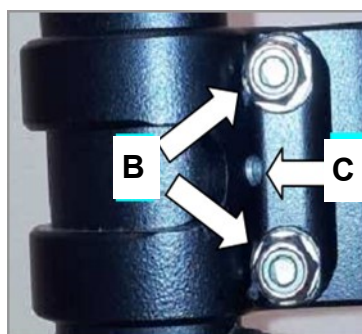

V-Design and V-Design 2.0 supports

Loosen the two bolts **A** and slide the support upward or downward to the desired height.

Fix the two bolts **A** hard.

If, after loosening the two bolts the support is too hard to move, remove the bolts, screw them from the inner side of the support, put and hold a little plate or washer between the two inner walls of the support and screw each bolt in order to expand the clamp.

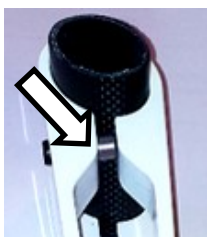

If the frame is in carbon fibre, you will see a little spacer (one on the upper side and another on the lower side) within the clamp. That is vital to avoid tightening the clamp to the extent of cracking the carbon fibre tube.

Never remove the spacers.

Expanding the clamp

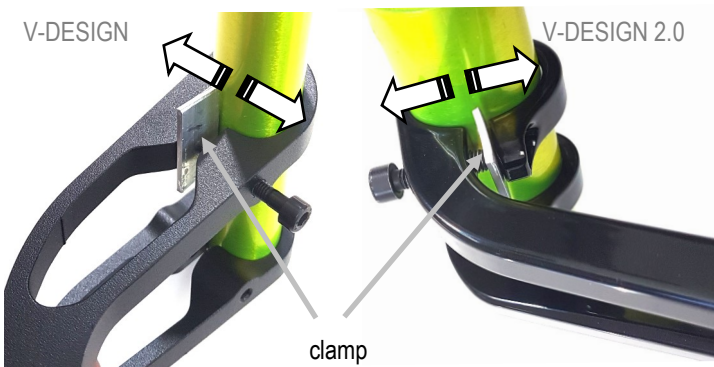

Remember that the front height adjustment can affect the seat inclination, so it is necessary to check and adjust the fork angle.



It is advisable to spread a drop of mild lock thread glue on the headless bolt **C**.



FORK ANGLE 1

system with spirit level

SERVICE MANUAL

WORK ON A FLAT EVEN SURFACE.

Whenever the seat height is changed or as periodic maintenance, check the fork angle and, if necessary, adjust it in order to have the fork axis perpendicular to the ground.

The fork adjustment system is based on the combination of two rings (**A1**, **A2**) with inclined plane.

The upper ring **A1** works on the fork support while the ring **A2** works on the ring **A1**.

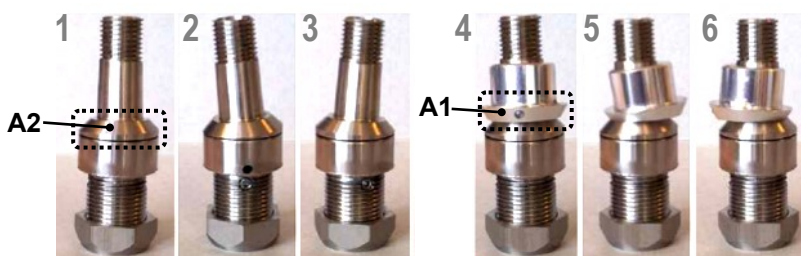
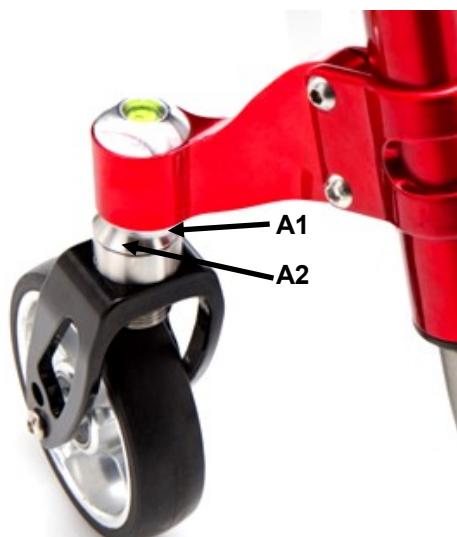

Bearing unit detached from the fork support.

Pictures 1, 2 and 3 show that the upper axle of the bearing unit, rotating on the lower axle (that allows the fork to turn), changes inclination thanks to the inclined plane of the ring **A2**. Pictures 4, 5 and 6 show three different inclinations of the ring **A1** keeping **A2** still. Each combination of the position of these two rings gives a different angle to the fork axis.

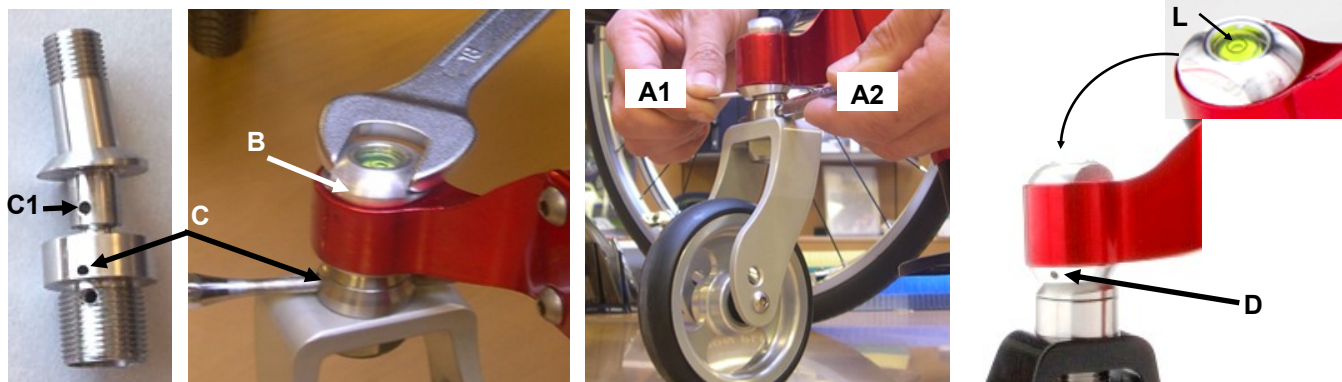

To carry out the adjustment, start with loosening the nut **B**.

To do so, you have to align external hole **C** and the internal hole **C1** of the adjustment axle and insert a steel (or an Allen key) through them (in the picture, the two parts are separate to make see the internal hole **C1**). With the pin inserted, you can turn the ring **A2**.

The nut **B** has to be loosened just enough to let the ring **A1** move.

Do not loosen the **B** too much, otherwise the system will be instable and it will be very difficult to adjust.

The play should be null or the minimum possible.

To turn the ring **A1**, insert a pin (or an Allen key) through the hole **D**.

Now, while keeping both pin inserted, turn ring **A2** (consequently the fork) without moving the ring **A1**.

While performing this operation check how the bubble of the spirit level **L** moves.

If, for the whole rotation of the ring **A2**, the bubble never passes through or close to the circle, it means you need to change the position of ring **A1**.

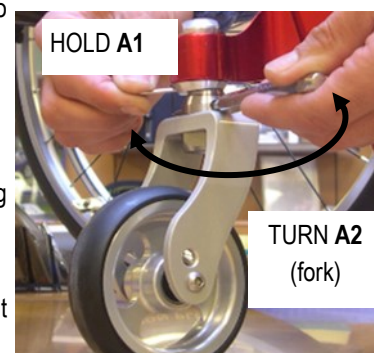

Follows next page



SERVICE MANUAL

FORK ANGLE 1

system with spirit level

Change position of A1

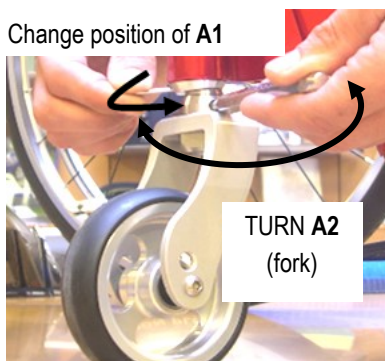

You have to adjust the two rings A1 symmetrically.
The two white and the two black circles show the two possible positions.



The two white arches show the possible different positions of the fork rotation axis (both at 90° to the ground).
The difference can be a few millimetres

Turn the ring **A1** a little in either direction and repeat the same operation above explained.

You have to repeat this procedure until the position of the ring **A1** allows the bubble to be very close to the circle of the spirit level.

At this stage, it is possible to turn both the ring **A1** and the fork together with very small movements until the bubble gets within the circle.

Check the nut **B** is not too loose (to prevent instability of the system) and not too tight (in this case the ring **A1** will not move).

To tighten or loosen the nut **B** during adjustment, you can usually use your finger (if it is too hard, you can use the spanner).

As mentioned at the beginning, the adjustment is necessary whenever modifying the seat inclination (front and/or rear height).

In such cases, the entity of the adjustment is not much, in other words, the point you start from is very near the goal. Therefore, the rotations of rings **A1** and **A2** will be by just a few degrees (clock or anticlockwise).

When you reach the correct angle, fix the system. Both pins should be inserted.

With one hand, hold the fork and the pin on the hole of the ring **A1** to control its position.

With the other bare hand, screw up the nut **B** as much as possible while checking the spirit level.

Now gradually tighten the nut **B** with the spanner.

If, while tightening, the bubble moves away from the circle, it means that the fork has moved.

To compensate such unwanted movement, turn the fork in the nut loosening direction and check the bubble.

It may seldom happen, though, that even the ring **A1** moves while tightening. In that case, adjust it back.

Make sure the bubble is within the circle and then fully tighten the nut **B**.

To reduce the risk of scratching the paint of the support around the nut, it is advisable to stick a shaped piece of female Velcro on the spanner.

This adjustment system often allows two different combinations **A1/A2** with the same correct result (axis perpendicular to the ground).

The two positions, even though they both give the 90° to the ground, are not exactly the same, in fact the distance between the rotation axle of the fork and the frame is different.

This means that you have to adjust the two forks symmetrically and this surely helps to adjust the "second" fork. Just have a look where the hole of the ring **A1** is with respect to the frame and symmetrically start from that point on the other fork to adjust.

Furthermore, the two combinations (when possible) allow solving the problem of interference between front wheel and footplate or tube. If the first found position results with such interference, just try the second position that may be better.

Differently, it will be necessary to change the size of front wheels or footplate position or the seat inclination (front or rear height).



It is advisable to pread a drop of mild lock thread glue on the nub **B**.

Follows next page



SERVICE MANUAL

FORK ANGLE 1

system with spirit level

When adjusting the fork angle avoid:

Working on ring **A1** and **A2** (fork) together from the beginning – this does not give any precise point of reference (as ring **A1** does in one any position that you can change if not correct).

Thinking that the front wheel must be orientated as when driving the wheelchair (the fork is part of the adjustment).

Keeping the nut **B** too loose while finding the correct angle.

Directionality check.

After adjustment, the wheelchair has to be tested to verify if it goes straight.

See also sheet DIRECTIONALITY.

Check both casters are touching the ground, if not, adjust their height.

If the wheelchair turns right or left, it means that you need to correct the adjustment.

If it turns right: the right fork is tilted inward (internal) or the left fork is titled outward (external).

If it turns left: the left fork is tilted inward or the right fork is titled outward.

Check which of the two to adjust.

The adjustment will be really of minimum entity.

The necessary rotation of either **A1** or **A2** (fork) is tiny.

Loosen the nut **B** as little as necessary.

Proceed with the adjustment making the bubble slightly move: - inwardly with respect to the wheelchair if the fork is external;
 - outwardly with respect of the wheelchair if the fork is internal

The bubble does not necessarily be perfectly concentric with the circle of the spirit level.

It is enough that it is within the circle or even adjacent.

The spirit level is, at origin, glued to the axle, therefore, there is a minimum tolerance while centring it.

After adjustment, the wheelchair has to go straight.

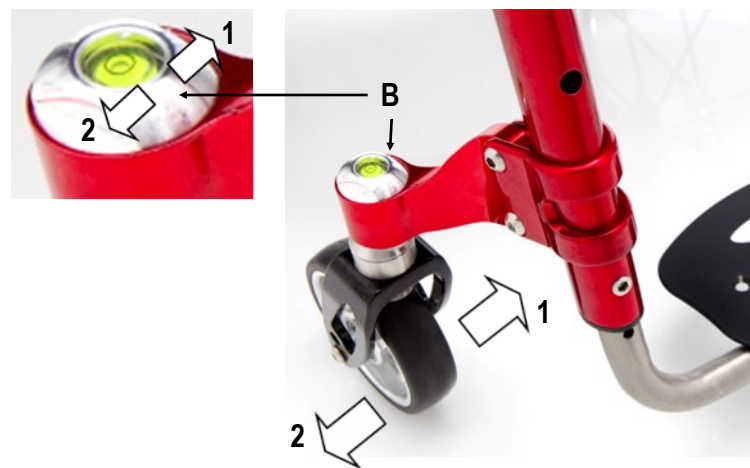



FORK ANGLE 2

V-Design fork support

SERVICE MANUAL

WORK ON A FLAT EVEN SURFACE.

Whenever the seat height is changed or as periodic maintenance, check the fork angle and, if necessary, adjust it in order to have the fork axis perpendicular to the ground.

To loosen the system:

loosen the two bolts **A**, the two headless bolts **B1 B2** and the nut **C**.

To adjust the fork:

Turn the fork axle, clock or anticlockwise, until the perpendicularity, 90° to the ground.

To make this operation easy, it is advisable to slightly tighten one of the two bolts **A** so that to allow for the fork axle rotation and keeping it in position after moving it.

You can measure the perpendicularity with the help of a square (or similar) vertically aligned to the caster; the caster has to be turn 90° with respect to the driving direction.

Alternatively, turn the fork by 360°: during the full turn, the wheel has to touch the surface in all positions.

To fix the system proceed with the following sequence:

- Tighten the two bolts **A** alternating them each quarter of a turn in order to allow for an even clamp torque.
- Tight and hold bolt **D** and tighten the nut **C**
- Finally, tighten the two headless bolts **B1 B2**

Directionality

Try the wheelchair out and verify it goes straight. See also DIRECTIONALITY

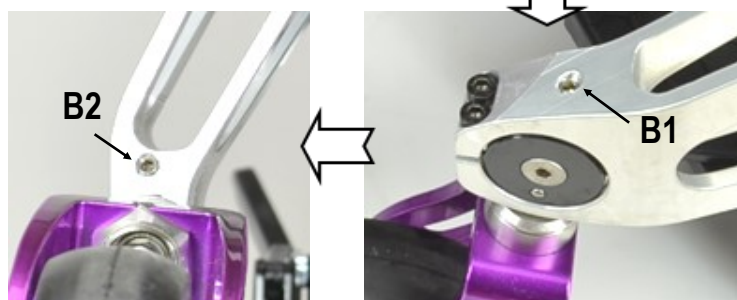
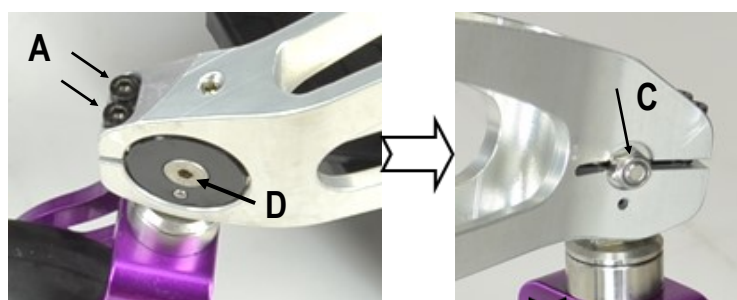
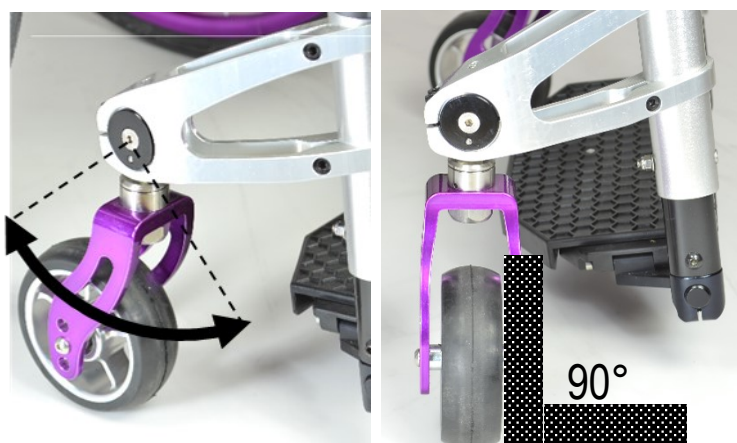
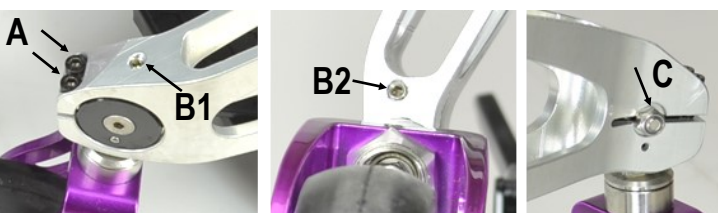

It is advisable to spread a drop of mild lock thread glue on the headless bolts **B1 B2**.



FORK ANGLE 3

Fork support V-Design 2.0

SERVICE MANUAL

WORK ON A FLAT AND EVEN SURFACE

Whenever the seat height is changed or as periodic maintenance, check the fork angle and, if necessary, adjust it in order to have the fork axis perpendicular to the ground.

The adjustment is possible by means of the four grab screws **G1**, **G2**, **G3** and **G4** that make the axle **P** turn on the fulcrum **F**.

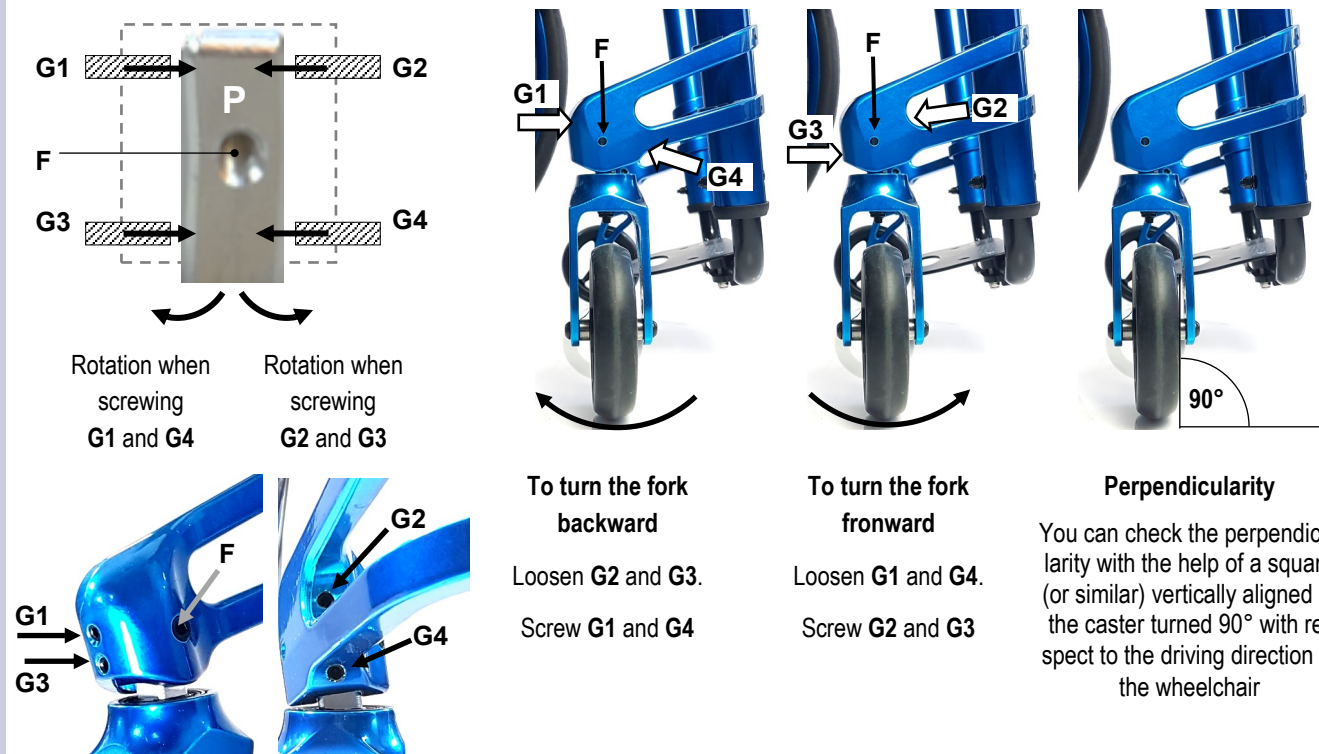

To turn the fork backward
Loosen **G2** and **G3**.
Screw **G1** and **G4**

To turn the fork forward
Loosen **G1** and **G4**.
Screw **G2** and **G3**

Perpendicularity
You can check the perpendicularity with the help of a square (or similar) vertically aligned to the caster turned 90° with respect to the driving direction of the wheelchair

To adjust the fork, once you know the direction (frontward or backward) towards which it is necessary to move the fork's axle, proceed as above-mentioned until reaching the correct angle.

You can also measure the perpendicularity by turning the fork by 360°: during the full turn, the wheel has to touch the surface in all positions.



If a headless bolt results hard to unscrew, DO NOT FORCE IT, but try to loosen the other two first.

If the fork's axle (the axle **P**) results hard to move, slightly loosen the bolt of the fulcrum **F** (remember to screw it after adjustment).

Once you reach the correct angle, screw all three headless bolts all the way down to the axle **P**, but without tightening.

In order to fix the system, tighten first one and then the other less than a quarter of a turn at once, the grab screws **G2** and **G4** (the front ones) checking the perpendicularity; in fact, it may slightly change during this phase.

Should that happen, correct the angle proceeding in the same manner.

When you have tightened both headless bolts **G2** and **G4**, you can tighten the headless bolt **G1** and **G3**.

Check the perpendicularity again and, if necessary, correct it.

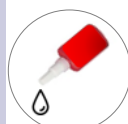

It is advisable to pread a drop of mild lock thread glue on all grab screws **G**.



SERVICE MANUAL

FORK ANGLE 3

Fork support V-Design 2.0

Follow the same instructions of the chapter *“Fork angle 3”*.





DIRECTIONALITY

SERVICE MANUAL

A very important aspect of any wheelchair is its directionality.

To check if the wheelchair goes straight, sit on it, push it and let it go until it stops.

If something is wrong, the slower the wheelchairs moves forward (momentum close to nothing), the more likely it turns right or left. Therefore, if no or irrelevant turn occurs, the wheelchair is properly adjusted.

Cause	Reason	Solution
SURFACE	The surface where the test is being performed is not even and flat	Test the chair on even and flat surface
REAR WHEELS	The rear wheel are not equally inflated	Inflate both tyres at the same pressure
	The tyres of the two rear wheel are different or differently worn out	Change the tyres
	The rear wheels are not adjusted at the same height	Adjust the rear wheel height
	The camber of right and left wheels are different or differently adjusted	Adjust the camber.
	The wheel, when turning, touches the side guard or the brakes	Fix or replace the side guard. Add spacer on the receiver. Adjust the brake.
	The wheels do not turn smoothly	Clean or change the bearings
FRONT WHEELS	The casters are not adjusted at the same height	Adjust the front wheels at the same height
	The tyres of the two front wheels are different or differently worn out	Change the wheels
	The fixing bolts of the fork/fork support/clamp are loosened	Check and tighten all fixing bolts
	The caster does not turn smoothly	Clean the bearings.
	Either or both forks are not adjusted so as their axis is perpendicular to the ground.	Adjust the fork axis inclination.
FOOTPLATE	The footplate tubes are adjusted at different height.	Adjust the tubes at the same height

If the wheelchairs does not go straight, in most cases the reason is the fork angle adjustment.

However, before working on the fork angle adjustment, check all the points above mentioned.

First, make the test along a flat even surface to check the directionality.

1 The correct adjustment has both forks perpendicular to the ground, that is, their axis at 90°.

2 If the wheelchair **TURN RIGHT**, the cause is one or more of the following:

The **RIGHT** fork is tilted **inwardly** and/or **backward**

The **LEFT** fork is tilted **outwardly** and/or **frontward**

3 If the wheelchair **TURN LEFTT**, the cause is one or more of the following:

The **LEFT** fork is tilted **inwardly** and/or **backward**

The **RIGHT** fork is tilted **outwardly** and/or **frontward**

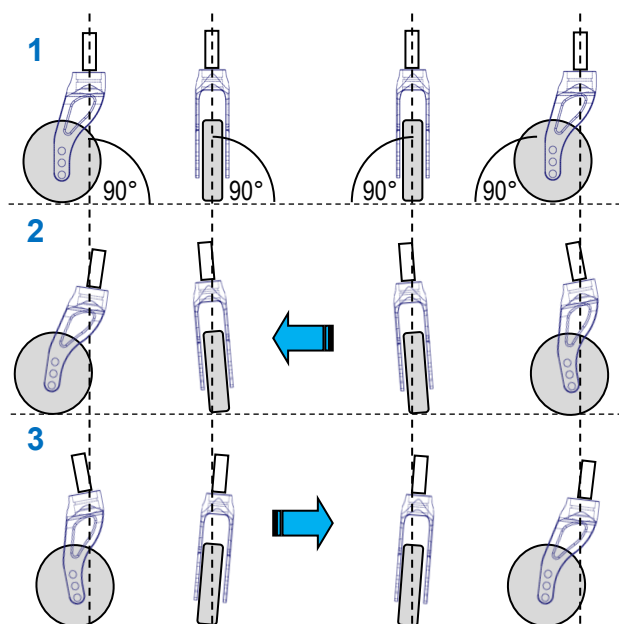

Follows next page



DIRECTIONALITY

SERVICE MANUAL

ADJUSTING THE DIRECTIONALITY

Check that the two forks are perpendicular to the ground. If they are not, proceed with the adjustment of the fork angle following the instructions on the sheet FORK ANGLE ADJUSTMENT.

If both forks axis are correct but the wheelchair still turns right or left, it means that the latitudinal angle is not perfect.

This may be due to hit, to improper pressure exercised on the fork or its support, or to a tiny imperfection among all parts fixed together due to their manufacturing tolerances.

System with hexagon

This adjustment systems does not allow for latitudinal (camber) adjustment, the only way to correct the angle is to put a sort of spacer between the upper or lower side of the fork support and the plate where it is fixed. The spacer can simply be a piece of plastic strapping (0.5 mm – 1 mm thick).

To incline the fork internally **1**, position the strapping on the upper side of the fork support.

To incline the fork externally **2**, position the strapping on the lower side of the fork support.

Other systems

Make sure the two bolts **A** are well tightened. In fact, if they are not fully tightened, the clamp will not take a proper hold on the frame and the support position may not be precise. Then, continue according to the type of system.

With spirit level

See sheet “fork angle 2” – directionality.

With fork support V-Design

If the operation above mentioned is not satisfactory, consult Reheatam s.r.l..

With fork support V-Design 2.0

Loosen all four grab screws **G**, remove the bolt **F** and slide off the fork complete with the axle **P**.

The axle has two side hollows **B** where you have to cast the flat inserts **C0** or the 1° tilted inserts **C1** that are recognizable thanks to two dots.

With the flat inserts **C0**, the axle keep its original inclination.

With the tilted inserts **C1**, the axle tilts by 1° right or left according to how to cast them in the hollows—see images.

Note: you can cast the inserts only as indicated in these images.

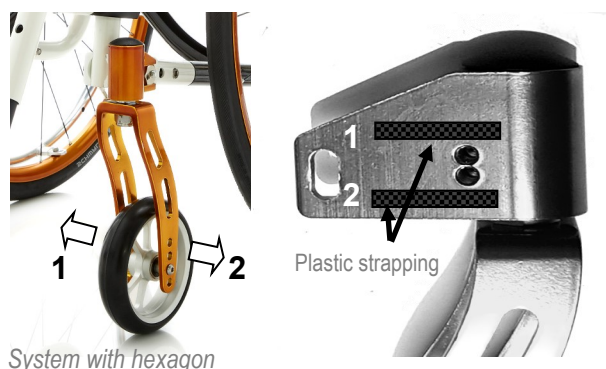

System with hexagon



System with spirit level

V-Design

V-Design 2.0

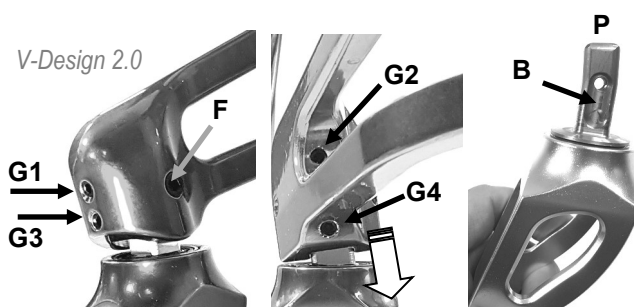

V-Design 2.0



0°



X Y 1°

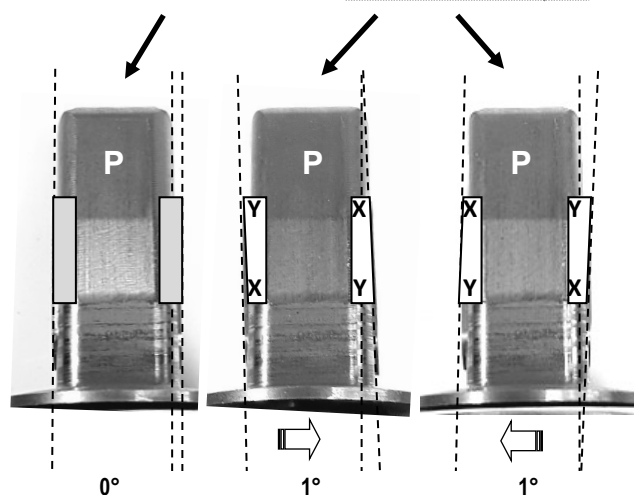

For the adjustment of the fork angle, see chapters “fork angle”.

Follows next page



DIRECTIONALITY

SERVICE MANUAL

Mounting back the fork of the system V-Design 2.0 and Joker Carbon.

Once you have casted the inserts **C0** or **C2**, it is advisable to try to screw the bolt **F** to check there is no difficulty. Sometimes, in fact, the holes of the inserts may have working burr that make the bolt hard to go through.

To mount the fork unit. Insert the axle **P** in the fork support paying attention to the orientation of the same axle. In fact, the axle is not straight, but it shows a bend.

Such bend must be facing to the rear of the wheelchair.

Insert and screw the bolt **F** without tightening it much (it is enough to screw it up to stop).

Adjust the fork angle — see sheet “fork angle 4”.

Note.

This type of adjustment can take place even at original assembly, therefore, you may find the inserts **C0** on one axle and **C1** on the other, for instance.

The wheelchair is not supplied with supplementary inserts, therefore, it will be necessary to order them when needed.

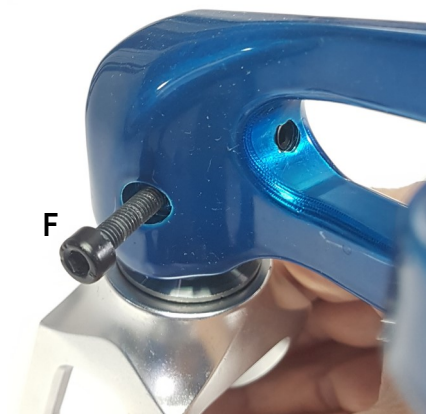
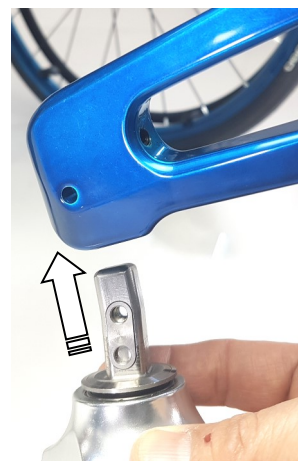
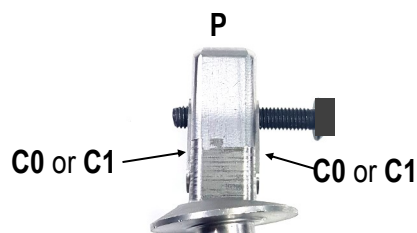

Axles without inserts

Until 2019 the axles had no inserts **C0** or **C1**. There were 0°, 1°rh and 1°lh axles. To adjust the directionality, it is necessary to change the axle.



For the adjustment of the fork angle and the removal of the fork support, see chapters “fork angle” and “fork support position”



SERVICE MANUAL

REAR HEIGHT



Adjustment every 1 cm.

Remove the bolt **A** on both sides of the wheelchair. The inner plate of the clamp-support **B** and the nut will come off.

Move the frame up or down until aligning the hole of the support **B** with one of those of the plate **C**.

Then insert the bolt **A**, the inner plate and the nut in its location.

When tightening this bolt, check that the inner plate of the clamp does not turn (you can hold it with your fingers), in fact, if it turns, the clamp will not take hold of the frame properly.

Finally tighten the bolt.

There is no need to use a spanner to hold the nut; in fact, its location on the inner clamp will hold it.

Check/adjust the brakes.

Remember that the rear height adjustment can affect the seat inclination, so it is necessary to check and adjust the fork angle.

The rear height adjustment can also change the point of balance (setting) of the wheelchair.

If necessary, adjust the setting.

When increasing the rear height by two or more positions, it may be necessary to cut off a little part the rear bottom side of the side guard, or reshape its bottom curve. That is to avoid interference with the two bolts at the back of the frame and/or with the support **B**.

When decreasing the rear height, the gap between side guard and frame will increase, but there is no need to modify the side guard.

Should the side plate be Full Carbon (with integrated side guards), the adjustment is the same, but with the advantage that, regardless the rear height you choose, you will never modify the side guard.

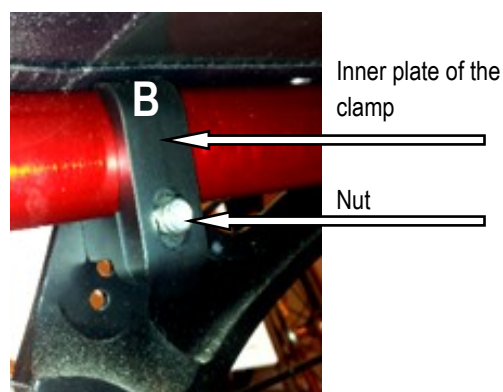
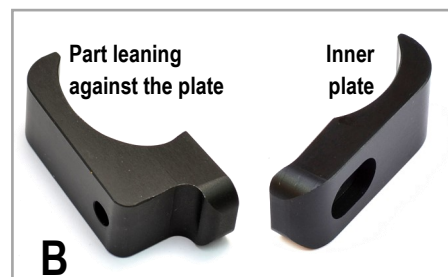



SERVICE MANUAL

SETTING (point of balance)

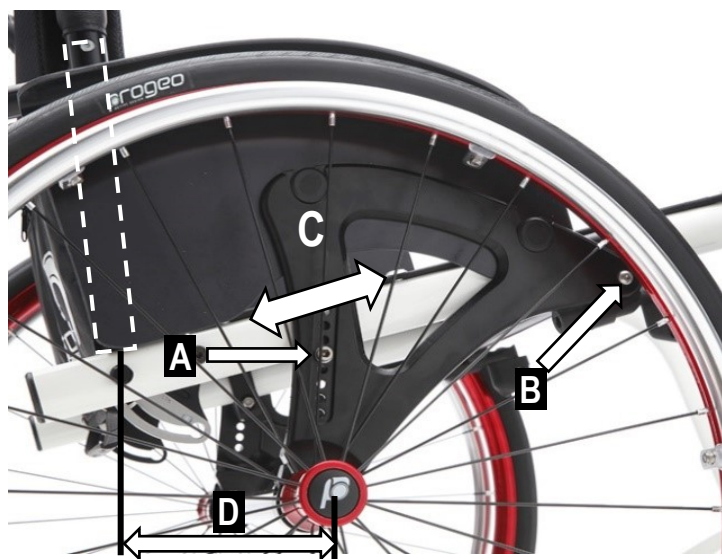

Remove the rear wheel.

Loosen the bolt **B** of the front support and put the wheel on.

Repeat the same operations on the other side of the wheelchair.

Loosen the bolt **A** of the rear support of both plates **C**.

There is no need to use a spanner to hold the nut; in fact, its location on the inner clamp will hold it. The front supports integrate the brake clamp and they also fix the front axle. The front axle is not necessary if the seat is of the type "rigid in carbon fibre".

Slide the frame forward or backward through the clamps to the desired position .

If the frames are too hard to move, loosen the bolts as much more as it is necessary.

It is possible to adjust the setting every millimetre.

Once reached the desired setting, tighten the bolts **A** and **B** on one side first .

Then measure the distance **X** between the rear side of the rear support and the bolt **E**.

Adjust and fix the other side respecting the same distance.

When tightening each bolt, check that the inner plate of the clamp does not turn (you can hold it with your fingers), in fact, if it turns, the clamp will not take hold of the frame properly.

It may be possible to scratch the frame, so it is advisable to proceed with care and do not force the system.

Remember that the setting adjustment can affect the seat inclination, so it is necessary to check and adjust the fork angle.

The predetermined settings that appear in the order form approximately have the following distance **D** (from the backrest's axis to the wheel's axis):

Prudential 9.0 cm; Standard 10.5 cm; Active 12.0 cm; Extreme 13.5 cm

Following the instructions above mentioned, you can reach a particularly prudential setting up to 5 cm (with distance **X** = 0, rear support in contact with the bolt **E**).

With the Full Carbon plate (with integrated mud guards), the adjustment is the same. It results easier to take the measure **X** from under the seat, between the inner plate of the rear support and the backrest plate.

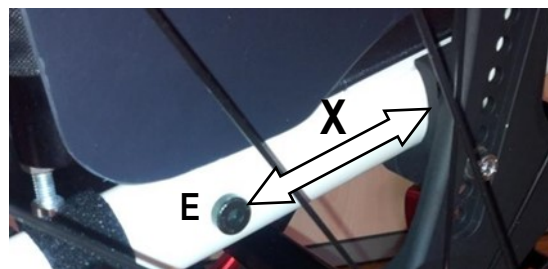

Inner plate of the rear support with embedded nut



The front support integrates the brake clamp and fixes the front axle

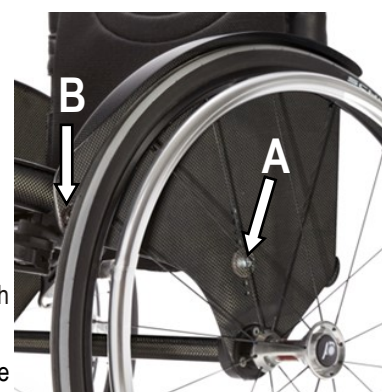

Full Carbon plate

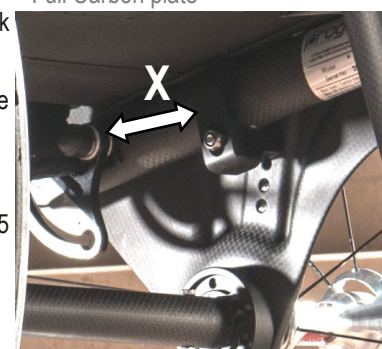



CAMBER AND CONVERGENCY

WORK ON A FLAT AND EVEN SURFACE

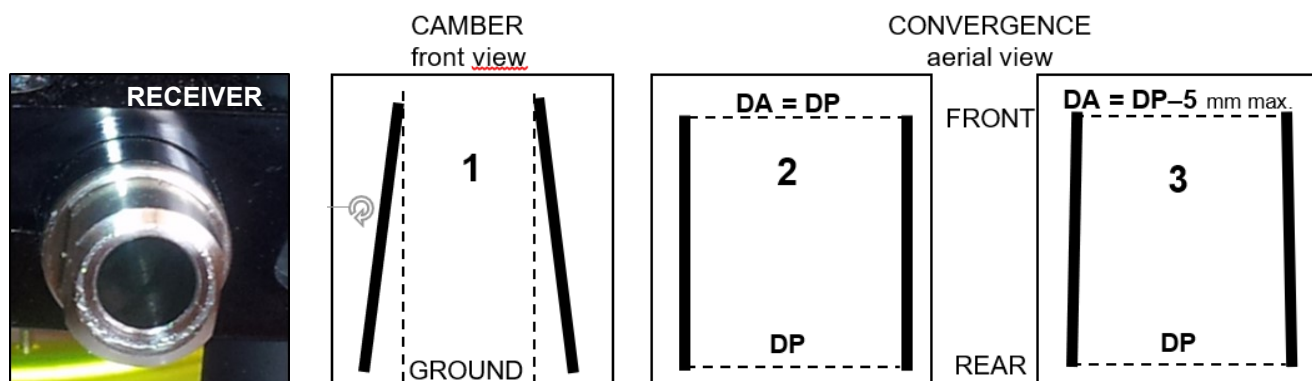

The wheel receiver gives the rear wheel camber (cambered receiver).

The two wheel receivers are fixed to the rear axle, thus, to adjust the convergence, it is necessary to turn the axle.

The drawing 1 shows same inclination (camber) of both rear wheels.

With cambered wheels, it is necessary to check/adjust the convergence, the distance between the two wheels in front and at rear.

The drawing 2 shows the aerial view of the wheels and the front distance **DA** is equal to the rear distance **DP**, while the drawing 3, **DA** is narrower than **DP** by maximum 5 mm.

We can say that a good convergence has the **front distance DA** equal to or slightly narrower than the **rear distance DP**.

DA must not be wider than **DP**. In such case, the fluency of wheelchair will not be good.

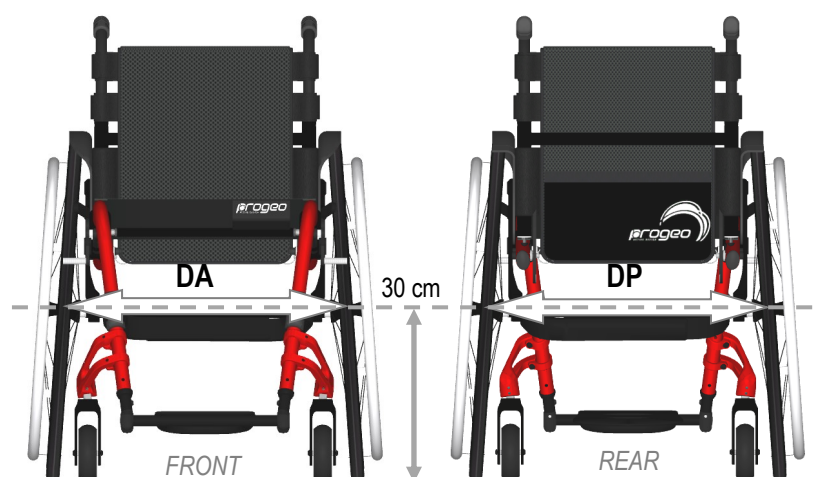
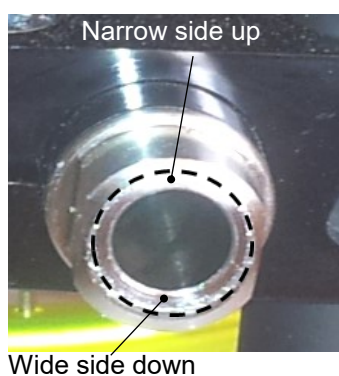

The hole of the cambered receiver, since it is inclined, is not centered.

Therefore, check the wheel receiver its narrow edge looking upward and its wider edge down. If opposite, the convergence is opposite, too (the wheels are opening apart at top!).

At 30 cm from the floor, take the measure centre-to-centre between the two tyres in front and at rear.

If the two measures are equal or the front one is slightly narrower (max. 5 mm), you have a good convergence as drawing 2 or 3.

If different, you have to adjust the convergence.

Se diferente, è necessario regolare la campanatura.

Follows next page



CAMBER AND CONVERGENCY

SERVICE MANUAL

Aluminum plate

Full Carbon plate

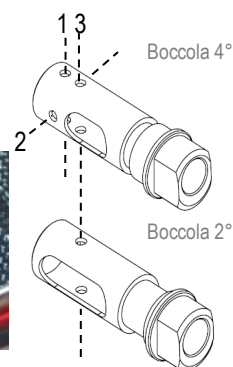
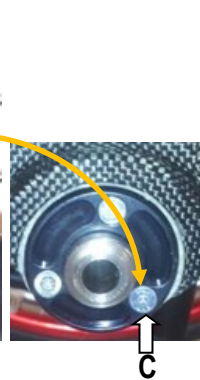
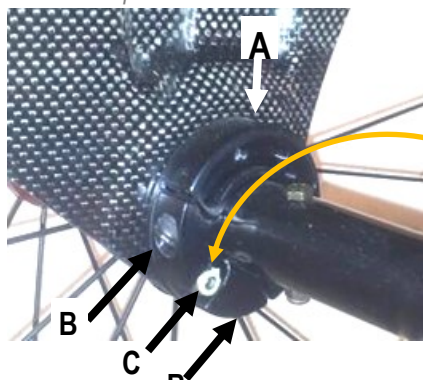
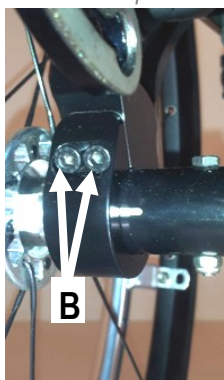

Aluminum plate: loosen the grab screw **A**.

Piastra Full Carbon: loosen the grab screw **A** and the bolt/nut **C**.

Loosen the above mentioned screws just enough to let you turn the rear axle with your hand but without the clamp sliding along the axle. If that occurs, you can continue with the adjustment. You will fix that later.

Turn the rear axle (clockwise or anticlockwise) and observe how and to what extent the wheels move.

A good reference is the bolt **D**, in fact its axis, should be perpendicular to the ground, except for the 4° receiver fixed in the center position (2) which is rotated by 90° with respect to the other two positions (1 and 3); in such case, the bolt **D** should be parallel to the ground.

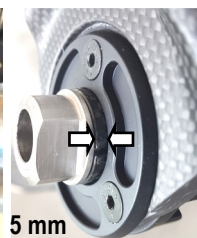
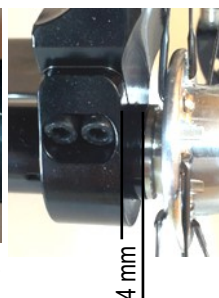
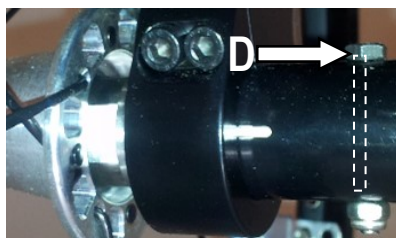
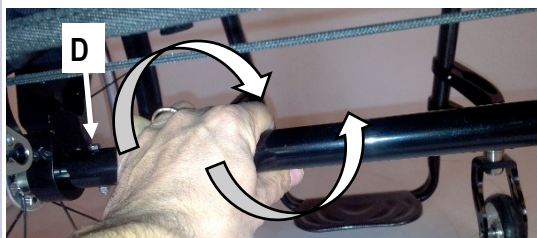

Take the measures again and if necessary, repeat the same operation until you reach the correct convergence, see previous page.

If the clamp moved when you loosened the fixing bolts, position the axle's end (not the receiver) at 4 mm from the clamp for the aluminium plate or 5 mm if Full Carbon plate and fix one side, first.

Aluminum plate: tighten the two bolts **B** alternatingly in order to make the clamp work properly. Finally, screw the grab screw **A**.

Full Carbon side plates: first tighten the two bolts **B** alternatingly and then the bolt/nut **C**. Warning: if you reverse that sequence, the lock plate may crack in its thinner part. Finally, screw the grab screw **A**.

Before fixing the other side, check the front wheels (considered already adjusted at the same height) are both touching the ground. If one do not touch, turn the frame on axle on its loosened side to the necessary extent.

If the quick release axle of the rear wheel hardly or do not pass through the receiver, loosen **A**, **B** (and **C**) and remove it. Then, tighten all parts again, but first pass the hole with a 1/2" reamer to remove any possible tiny deformation (see also adjustment sheet "quick release axle").

It may be a little harder to position and fix the other side due to the pressure given by the seat canvas, but you have to respect the same distance.

Check the measure from a fix point of the frame to the centre of the tyre on each side. Should there be a difference greater than 2-3 mm, check the distance between clamp and axle as above mentioned.

If necessary, correct the adjustment.

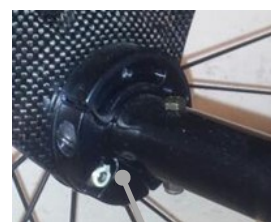

Thinner side of the lock plate

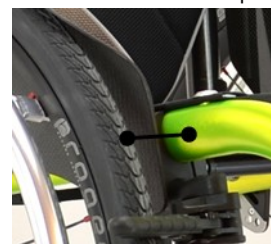



BRAKE

SERVICE MANUAL

WHEN ADJUSTING THE BRAKES, THE TIRES MUST BE INFLATED TO THE CORRECT PRESSURE (except solid tyre)

The position of the brake depends on the position of the rear wheel.

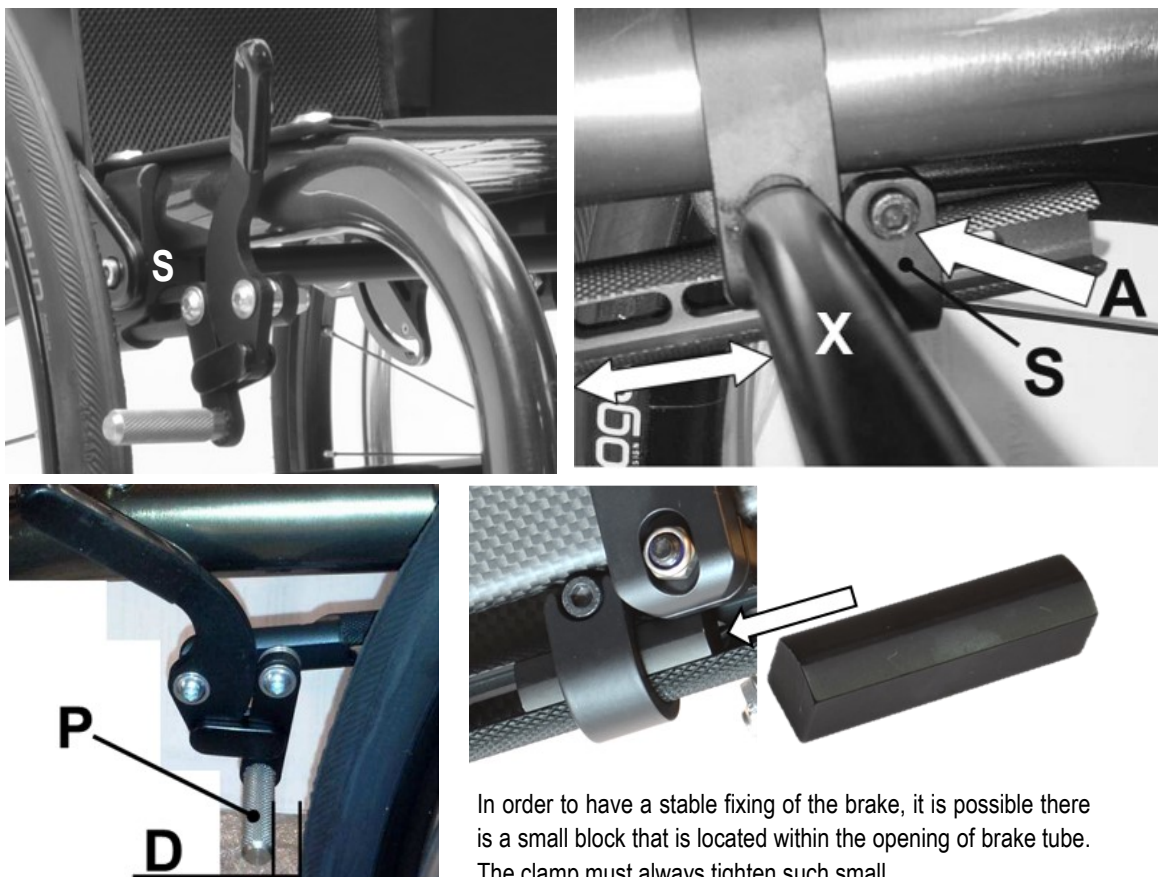

In order to have a stable fixing of the brake, it is possible there is a small block that is located within the opening of brake tube. The clamp must always tighten such small.

Loosen the bolt **A** that is located in the inner side of the support **S**.

Position the brake-knurled rod **P** at a distance **D** of a few millimetres and parallel to the ground.

Temporarily tighten the bolt **A** and try the brake out to check if the adjustment is good.

If necessary, repeat the same operation to reach the good adjustment.

A good adjustment has the brake not too hard to engage but braking, so you will have to find the suitable compromise.

Once reached the correct position, tighten the bolt **A**.

Carry out the same operation on the other side.

The axle **X** is not necessary with "rigid seat in carbon fibre".

The adjustment for the sport brake is the same except for the distance **D**, in fact, the brake, in its resting position is far away from the tyre. Just make a few tries.



Note: if the frame is rather short (short seat depth); there may be interference between brake and the frame curve. In such case, it is necessary to move the rear wheel back (point of balance of the wheelchair) accordingly.



BRAKE SPACING

SERVICE MANUAL

In several cases, the distance between the tyre and the frame can be such as to make need moving the knurled rod **P** more external.

When originally assembling the wheelchair, such possible modification is already taken into account.

In case of a post-sale modification that results in the rear wheels being more external (from 0° to 2° or 4° camber; seat width enlargement; a different wheel), the brake may not work efficiently anymore, therefore, you will have to move the knurled rod. The brake is efficient if the knurled rod **P** is at least 5 mm beyond the tyre's mid-line.

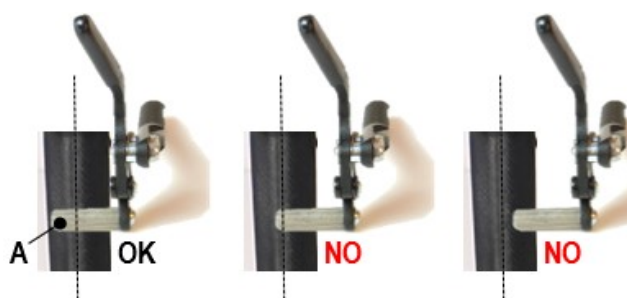

In all cases, check the brake efficiency.

Remove the bolt **B**. In order to remove it, put the knurled rod in a vice and heat it with a hot air blower because the bolt is locked with strong lock thread glue. DO NOT FORCE WHEN UNSCREWING IT, you may damage the bolt's head irremediably.

Once you have removed the bolt, the knurled rod comes off, too. Replace the bolt **B** according to the spacer **C** (7 or 11 mm) you will add.

Put some strong lock thread glue on the bolt **B** and assemble the spacer **C** and the knurled rod **A**.

Put the knurled rod in a vice and tighten the bolt **B** hard.

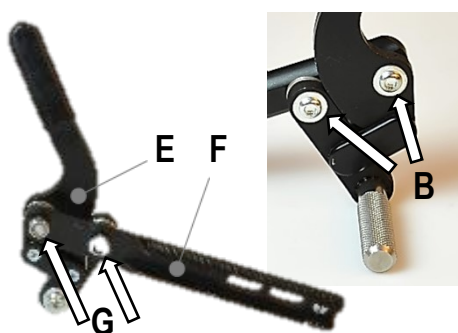
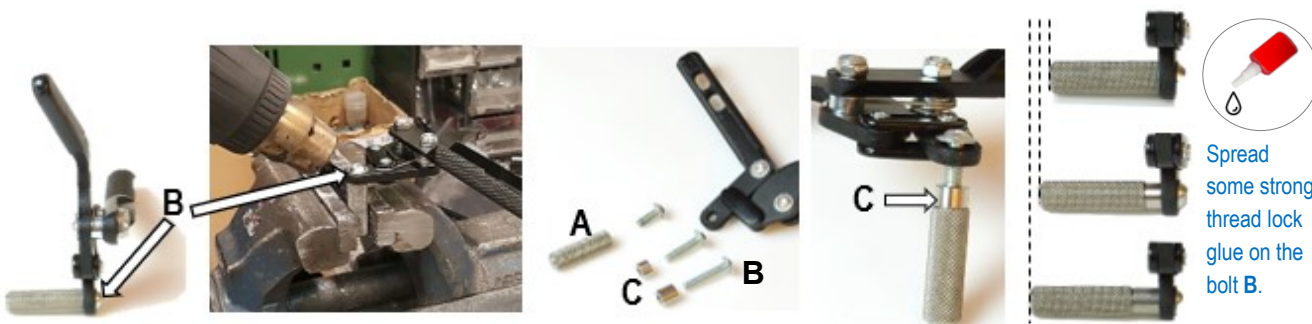

It is also possible to move the brake structure **E** from the adjustment rod **F**.

Remove the two nuts **G** and then the two bolts **B**.

Remove the spacers **H** around which the spring is assembled.

Observe how the spring is assembled because you will have to assemble it back later in the same way (you can always have a look at the other brake that is symmetric).

Insert the spacers **H** (H_1 = original; H_2 = 7 mm longer).

Position the spring and assemble the structure to the adjustment rod.

Start screwing the two bolts **B** all the way down and then the two nuts **G**.

Should the brake movement be hard, slightly loosen the bolts **B**.





SERVICE MANUAL

FOOTPLATE DISTANCE WITH 7° FRAME

The particular characteristic of this MODEL is the 7° front frame taper.

As it is visible from the picture, the longer the footplate distance **DP**, the narrower the room **X** between the two frames at footplate's level.

According to that, when adjusting the footplate distance, it is necessary to keep the 7° taper and increase or decrease the room **X**.

After adjustment, the forks have to be perpendicular to the ground. That will tell you keep the 7° frame taper.

All footplates available for this model allows for such adjustment.

HEIGHT ADJUSTMENT EVERY 1.5cm

Remove the bolts **A** and their corresponding nuts and washers **B**.

Slide the footplate tube up or down until the necessary height.

Insert the bolts through the nearest holes and tighten.

Where present, it is possible to use the second hole **C**, too.

To reach short footplate distances, one can, both at original assembly or afterwards, cut off the frame just below the fork support (regardless its positioning).

It should be clear that the possible adjustment may then be limited.

After adjustment, check that between the lower side of the footplate and the ground there is at least 2 cm and that there is no interference between footplate and casters.

Rubber adaptor for round footplate tube on elliptical tube (from 2019).

The round footplate tube needs the adaptor **F** to fit the elliptical frame tube. The adaptor's hole is not centred, therefore, you have to pay attention to mounting right and let adaptors in the same way.

- If the centre of the fixing hole **A** is at 20 mm from the lower extremity of the frame tube, the adaptor **F** is usually mounted with its narrower side facing forward. In order to avoid squeezing the adaptor too much, do not tighten the bolt very hard.
- If the centre of the fixing hole **A** is further than 20 mm, thus even the hole **C**, the adaptor **F** is glued to the frame and assembled with its narrower side backward. This is due to the fact that when you tighten the bolt, the tube will lean against the inner side (which is very close) of the frame tube and that guarantees the stability of the system. The bolt for this fixing includes a spacer **G** under the bolt's head. This way, the bolt will run in beyond the frame tube wall; if so, it would impede the correct fixing of the footplate tube. (This fixing is of course also possible if the point **A** is at 20 mm).
- To turn the adaptor, (if it is not glued), remove the footplate tube, slide the adaptor off and mount it reversed.

With elliptical footplate tubes, the adaptor is not present.

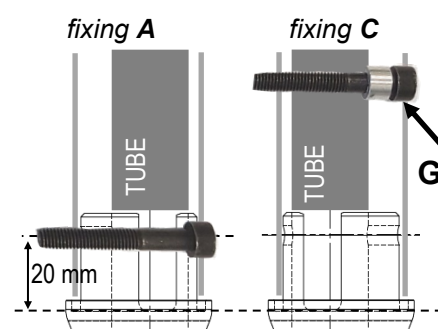
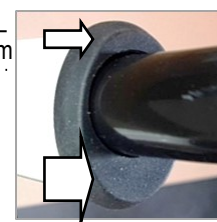
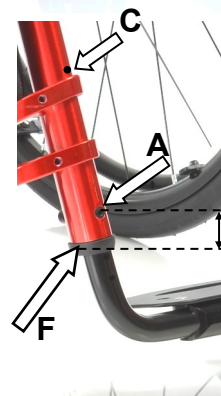
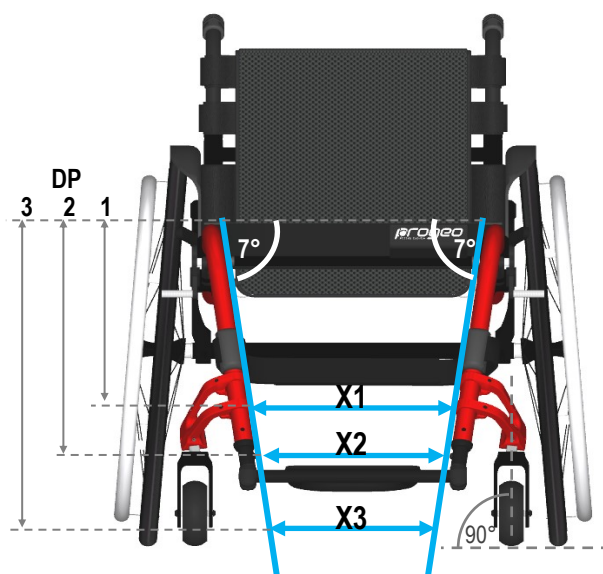



FOOTPLATE DISTANCE

JOKER CARBON

SERVICE MANUAL



HEIGHT ADJUSTMENT EVERY 1.5 cm

Proceed as for the model Joker, see chapter “Footplate distance with 7° frame”, in fact, only the footplate support is different.

Screw off the bolt **A** of both side of the frame.

Slide the tubes to the necessary height.

Make sure the height of the two sides is the same.

Insert the bolt **A** paying attention to fitting it with no effort into the threaded hole **B** on the rear side of the support **C**.

The footplate tube's holes and the hole of the support **B** must be aligned.

Finally, tighten the bolt **A** on both sides of the frame.

Do not force screwing the bolt, you may damage the thread of the hole **B**. Should that occur, you can remedy by pass the threaded hole with a M5 tap starting from the rear side of the support.

If the thread is too damaged to be repaired, you can pass the hole with a 5 mm drill bit and fix the tube with a longer bolt, washer and nut.

You can not change the support **C**.

After adjustment, check that between the lower side of the footplate and the ground there is at least 2 cm and that there is no interference between footplate and casters.

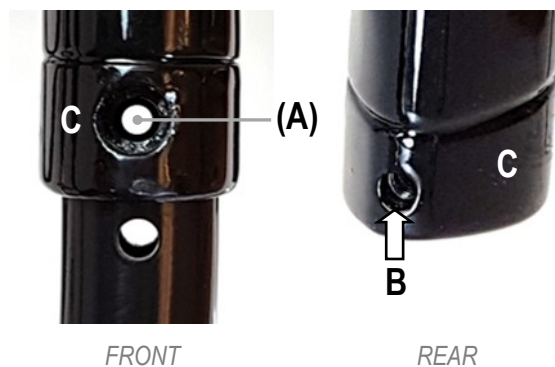



SERVICE MANUAL

ALUMINUM FOOTPLATE FOR 7° FRAME

Angle adjustment:

Loosen the grab screw **A** and the bolt **B** of both supports (right and left) just enough to be able to turn the footplate.

Adjust the inclination of the plate until the necessary angle.

Finally, tighten the bolt **B** first and then the grab screw **A** of both supports.

Note: the supports for elliptical tube and for round tube have the same bolts.

Height adjustment:

Loosen the grab screw **A** and the bolt **B** of both supports (right and left) until you can both turn and horizontally slide the footplate through the supports.

That will allow you to make the distance **X** wider or narrower and thus keep the 7° frame taper.

Carry out the adjustment in height as mentioned on the sheet "footplate distance for 7° frame".

Slide the horizontal tube of the footplate through the supports in order to keep the 7° frame taper that will have as a result the fork axle at 90°. Check that.

Check the footplate is centred with respect to the supports.

Adjust the footplate angle as above mentioned.

Finally, tighten the bolt **B** first and then the grab screw **A** of both supports.

Position adjustment:

4 positions: internal; 2/3 internal; 2/3 external; external

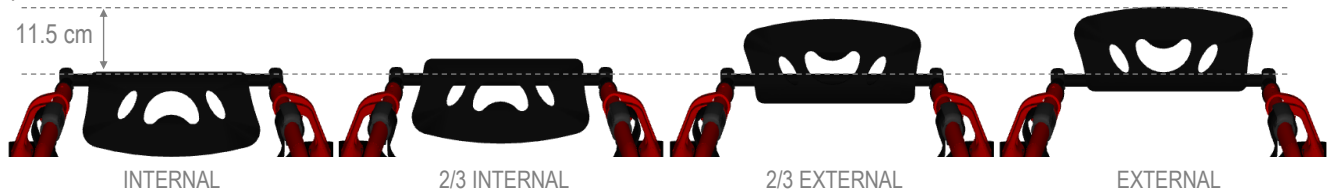

Remove the 4 bolts fixing the plate and use the other set of holes.

It is also possible to reverse the footplate tubular from internal to external and vice-versa.

Loosen the grab screw **A** and the bolt **B** as above mentioned for height adjustment.

Remove the bolts/nuts that fix the footplate tubes (see sheet "footplate distance for 7° frame") and slide the footplate-group off.

Reverse the assembly, fix the tube at the necessary height and adjust the angle as above mentioned, keeping in mind to respect the 7° taper.

Note: you can remove and insert the footplate-group into the frame tubes without loosening the grab screw **A** and the bolts **B**, thus keeping the distance **X**; the operation, though, will result a little more difficult because the distance between the two footplate tubes at their upper side is always wider than the distance of the frame tubes at the insertion point.

To remove the footplate-group, the frame will widen apart as the footplate tubes slide off. To help the tube come off, you can hit the plate with your hand or gently with a mallet.

On the other hand, to mount it back, you have to insert one footplate tube for approx. 1cm, widen the frame until you can insert the other footplate tube. That is the point of the maximum pressure, then, as you slide the tubes in, you will notice that the movement will be easier.

If there is the rubber adaptor, it is useful, if possible, to remove it from the frame and slide it along the footplate tube; that will create more room for the passage of footplate.

It will be necessary to adjust the inclination.

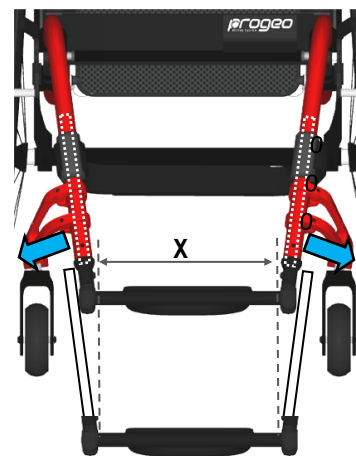
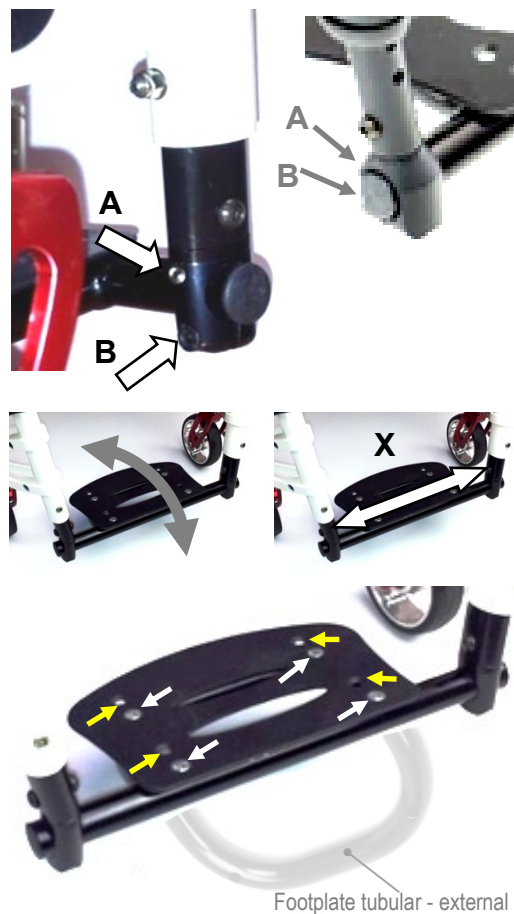

Keeping the distance **X**, you should notice that, at the insertion point, the distance between the footplate tubes is wider than the distance of the frame tubes.



SERVICE MANUAL

CARBON FIBRE FOOTPLATE FOR 7° FRAME

Angle adjustment:

Loosen the grab screw **A** and the bolt **B** of both supports (right and left) just enough to be able to turn the footplate.

Adjust the inclination of the plate until the necessary angle.

Finally, tighten the bolt **B** first and then the grab screw **A** of both supports.

Note: the supports for elliptical tube and for round tube have the same bolts.

Height adjustment:

Loosen the grab screw **A** and the bolt **B** of both supports (right and left) until you can both turn and horizontally slide the footplate through the supports.

That will allow you to make the distance **X** wider or narrower and thus keep the 7° frame taper.

Carry out the adjustment in height as mentioned on the sheet "footplate distance for 7° frame".

Slide the horizontal tube of the footplate through the supports in order to keep the 7° frame taper that will have as a result the fork axle at 90°. Check that.

Check the footplate is centred with respect to the supports.

Adjust the footplate angle as above mentioned.

Finally, tighten the bolt **B** first and then the grab screw **A** of both supports.

Position adjustment:

2 positions: internal; external

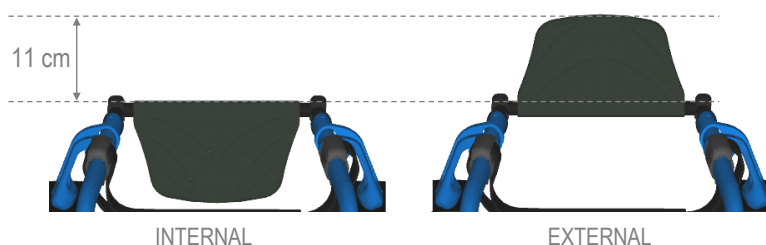

In order to change position, loosen the grab screw **A** and the bolt **B** as above mentioned for height adjustment.

Remove the bolts/nuts that fix the footplate tubes (see sheet "footplate distance for 7° frame") and slide the footplate-group off.

Reverse the assembly, fix the tube at the necessary height and adjust the angle as above mentioned, keeping in mind to respect the 7° taper.

Note: you can remove and insert the footplate-group into the frame tubes without loosening the grab screw **A** and the bolts **B**, thus keeping the distance **X**; the operation, though, will result a little more difficult because the distance between the two footplate tubes at their upper side is always wider than the distance of the frame tubes at the insertion point.

To remove the footplate-group, the frame will widen apart as the footplate tubes slide off. To help the tube come off, you can hit the plate with your hand or gently with a mallet.

On the other hand, to mount it back, you have to insert one footplate tube for approx. 1cm, widen the frame until you can insert the other footplate tube. That is the point of the maximum pressure, then, as you slide the tubes in, you will notice that the movement will be easier.

If there is the rubber adaptor, it is useful, if possible, to remove it from the frame and slide it along the footplate tube; that will create more room for the passage of footplate. It will be necessary to adjust the inclination.

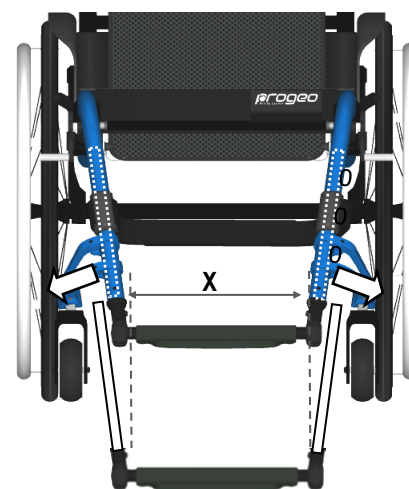
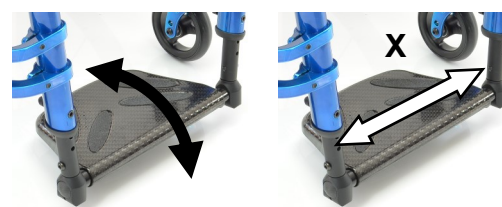
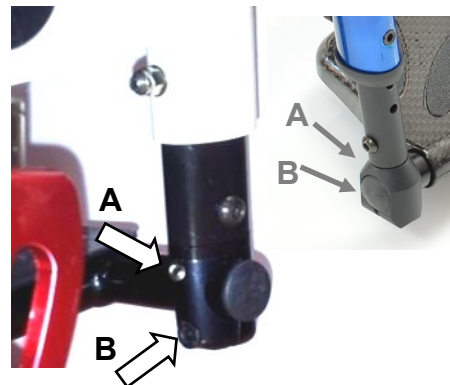

Keeping the distance **X**, you should notice that, at the insertion point, the distance between the footplate tubes is wider than the distance of the frame tubes.



SERVICE MANUAL

ALUMINIUM FOOTPLATE WITH CURVED TUBES FOR 7° FRAME

Angle adjustment:

Remove the two bolts and nuts **A** that fix the footrest plate to the clamp **B**.

Loosen the two bolts and nuts **C** that fix the clamp **B** to the two tubes.

Turn the clamp until the necessary inclination.

Lay the footrest plate on the clamp to check the inclination.

Firmly tighten the bolts and nuts **C**.

Finally. Fix the plates with the two bolts and nuts **A**.



Height adjustment:

Remove the two bolts and nuts **A** that fix the footrest plate to the clamp **B**.

Loosen the two bolts and nuts **C** that fix the clamp **B** to the two tubes until you can easily turn the clamp and slide the two tubes horizontally through it.

That will allow you to make the distance **X** wider or narrower and thus keep the 7° frame taper. Carry out the adjustment in height as mentioned on the sheet "footplate distance for 7° frame".

Slide the horizontal tube of the footplate through the supports in order to keep the 7° frame taper that will have as a result the fork axle at 90°. Check that.

Check the footplate is centred with respect to the supports.

Adjust the footplate angle and fix the system as above mentioned.

Position adjustment:

4 positions: internal; 2/3 internal; 2/3 external; external

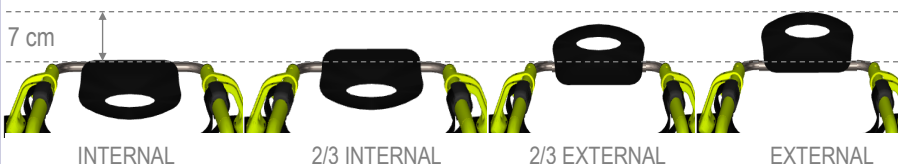

Remove the two bolts and nuts **A** and fix the plate using the other two holes on the same plate. You can also fix the plate facing front or rear without the need (even though possible) of reversing the clamp.

If you wish to reverse the clamp, remove the bolts/washer/nuts fixing the footplate tubes (see "footplate distance for 7° frame") and slide the group "footplate".

Reverse the assembly, fix the tube at the necessary height and adjust the angle as above mentioned, keeping in mind to respect the 7° taper.

Note: you can remove and insert the footplate-group into the frame tubes without loosening the grab screw **A** and the bolts **B**, thus keeping the distance **X**; the operation, though, will result a little more difficult because the distance between the two footplate tubes at their upper side is always wider than the distance of the frame tubes at the insertion point.

To remove the footplate-group, the frame will widen apart as the footplate tubes slide off. To help the tube come off, you can hit the plate with your hand or gently with a mallet.

On the other hand, to mount it back, you have to insert one footplate tube for approx. 1cm, widen the frame until you can insert the other footplate tube. That is the point of the maximum pressure, then, as you slide the tubes in, you will notice that the movement will be easier.

If there is the rubber adaptor, it is useful, if possible, to remove it from the frame and slide it along the footplate tube; that will create more room for the passage of footplate. It will be necessary to adjust the inclination.

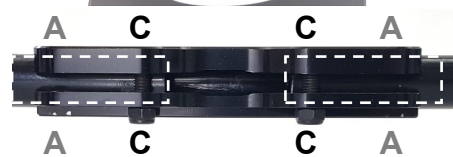
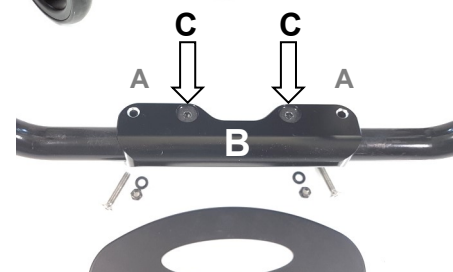
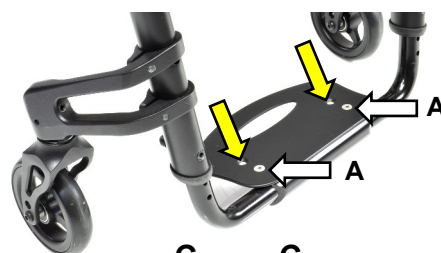

External footplate

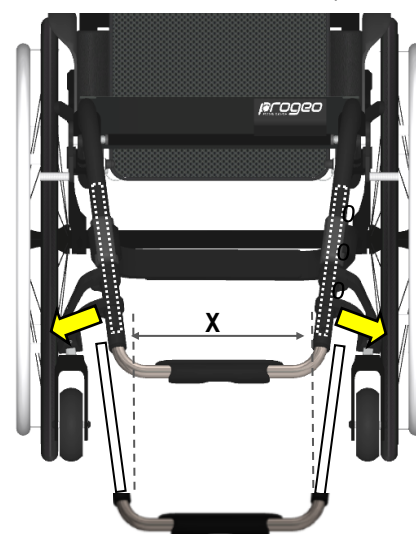

Keeping the distance **X**, you should notice that, at the insertion point, the distance between the footplate tubes is wider than the distance of the frame tubes.



SERVICE MANUAL

FIXED CARBON FIBRE FOOTPLATE

FOR 7° FRAME

Angle adjustment:

This footplate is **not adjustable** in angle.

Height adjustment:

Loosen the two bolts **A** that you find on the lower side of the footrest plate and that fix the same plate to the tubes.

The footrest plate is fixed to the tubes by means of a half-moon insert which is positioned inside the slotted tubes.

That will allow you to make the distance **X** wider or narrower and thus keep the 7° frame taper. Carry out the adjustment in height as mentioned on the sheet "*footplate distance for 7° frame*".

Slide the horizontal tube of the footplate through the supports in order to keep the 7° frame taper that will have as a result the fork axle at 90°. Check that.

Check the footplate is centred with respect to the supports; the two slots **B** should come out from the plate to the same extent (in the image here aside, you should notice that the plate is not centred).

Position adjustment:

This footplate is **not adjustable** in position.

Position: only internal.

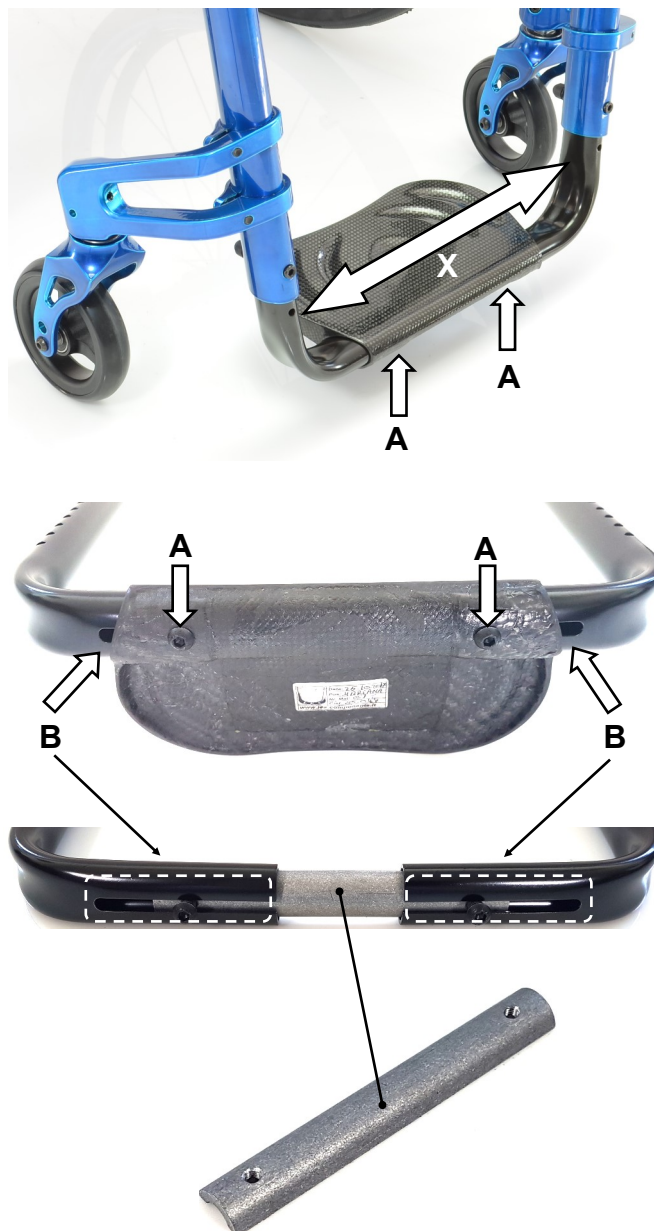



SERVICE MANUAL

FOOTPLATE DISTANCE FOR “ZERO” FRAME

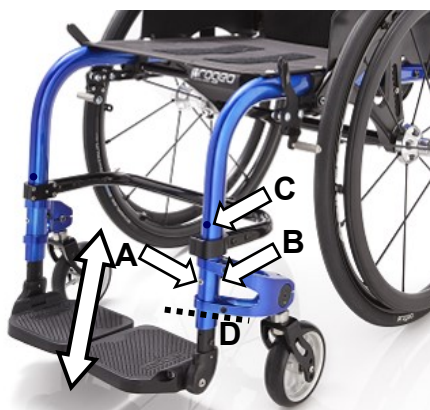

HEIGHT ADJUSTMENT EVERY 1.5cm

Remove the bolts **A** and their corresponding nuts and washers **B**.

Slide the footplate tube up or down until the necessary height.

Insert the bolts through the nearest holes and tighten.

Where present, it is possible to use the second hole **C**, too.

If necessary, you can adjust the height of the two independent footplates differently.

With one piece footplate, the two tube have, of course, to be adjusted at the same height.

The footplate tube can be either short (1) or long (2).

The short tube has two positionings for the adjustment support (RH and LH) in order to reach short footplate distances.

The long tube has only one positioning for the adjustment support and it is design for longer footplate distances.

The tubes for double footplates and one piece footplates are the same, but the adjustment support is different.

To reach the shortest footplate distance, one can, both at original assembly or afterwards, cut off the footplate. The dotted lines **D** in the pictures above show up to where you can cut off the frame: just below the fork support (regardless its positioning).

It should be clear that the possible adjustment may then be limited.

The adjustment support is fixed to the tube with the bolt **E** on which a drop of strong lock thread glued is spread. Should you need to change the position of the support (only short tube), in order to unscrew the bolt, you may need to heat it first. When you assemble the support, spread a drop of strong lock thread glue on it.

After adjustment, check that between the lower side of the footplate and the ground there is at least 2 cm and that there is no interference between footplate and casters.

Rubber adaptor for round footplate tube on elliptical tube (from 2019).

The round footplate tube needs the adaptor **F** to fit the elliptical frame tube. The adaptor's hole is not centred, therefore, you have to pay attention to mounting right and let adaptors in the same way.

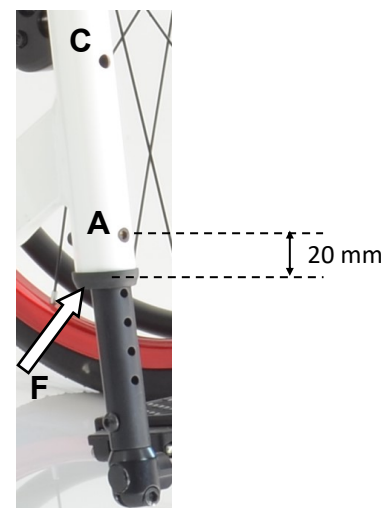
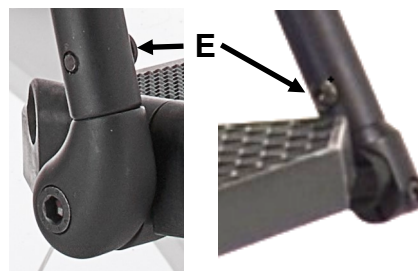
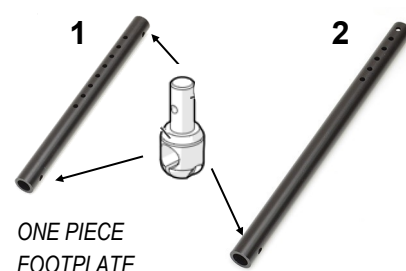
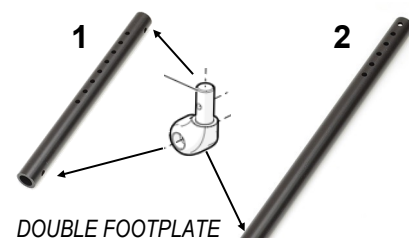

fixing **A**

fixing **C**

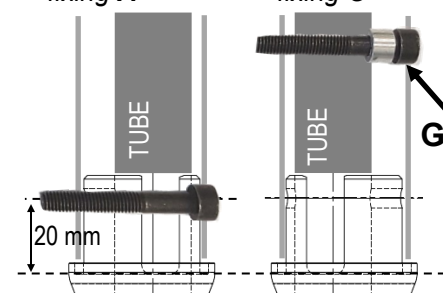



FRONT FRAME RIGIDIZER FOR JOKER “ZERO”

SERVICE MANUAL

The configuration with parallel frames (JOKER “ZERO”), thanks to the front frame rigidizer, allows for double or flip-up footplates.

You can adjust the rigidizer in height.

Loosen the 4 bolts **A** and the headless bolt **B** on both sides.

Slide the rigidizer up or down. Make sure right and left side are at the same height and finally fix the 4 bolts **A** first and then the headless bolt **B**.

After fixing the bolts **A**, the gap **C** between the two plates of the clamp has to be the same up/down and front/rear.



With carbon fibre frame do not tighten the headless bolt B too hard, this may cause serious damage the carbon fibre, up to breakage.



With the V-Design fork support, you can also fix rigidizer's supports between the two arms of the fork supports, unless, in that point, there is the bolts fixing the footplate tubes.

Should you need to move the rigidizer from above to within the V-Design, or the other way round, you need to remove the footplate tubes, the fork supports and the rigidizer.

Then, reassemble all parts in the wanted sequence.

In such case, it will be necessary to adjust the front height, see sheet FRONT HEIGHT ADJUSTMENT 2– sliding system V-DESIGN.

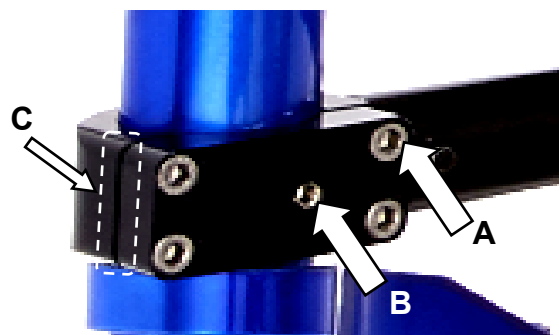



SERVICE MANUAL

DOUBLE FOOTPLATE FOR JOKER “ZERO”



ANGLE ADJUSTMENT

Loosen the bolt **A**.

Turn the plate clock or anti clock wise.

Once you find the correct inclination, tighten the bolt.

If necessary, you can adjust the inclination of the two independent footplates differently.

POSITIONING

2 positions: 2/3 internal or 2/3 external.

To reverse the position, remove the footplates complete with tubes and assemble right side to left and the other way round—see also chapter “*height adjustment*”. It may be necessary to adjust the angle.



FRICTIONING THE ROTATION

To adjust the friction of the footplate rotation movement, tighten or loosen the bolt **B** (the corresponding nut is held within it housing). Usually, when the footplate is lifted up the adjustment holds it in place.

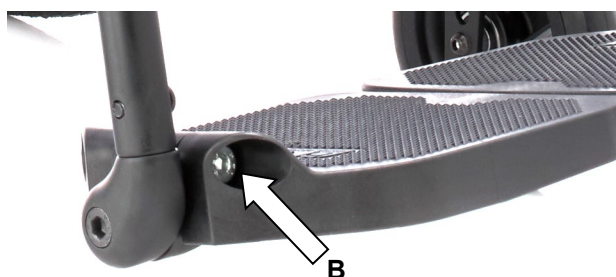

Particularity

Should you need a plate positioned 2/3 internal and the other 2/3 external, it is necessary to have two adjustment supports of the same side (two right or two left).

Note: for right hand side we intend right facing back, thus, if assembled on the left, it will be left facing front; for left hand side we intend left facing back, thus, if assembled on the right, it will be right facing front;

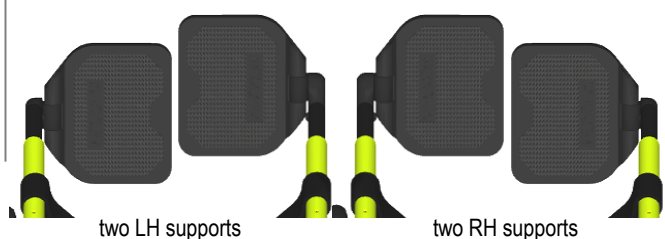



ONE PIECE FLIP-UP ALUMINUM FOOTPLATE FOR JOKER "ZERO"

SERVICE MANUAL



ANGLE ADJUSTMENT

Leave the footplate engaged in the using position.

With round tube: loosen the bolt **A** of both adjustment supports.

With elliptical tube: loosen the grab screw **A1** and the bolt **A** of both adjustment supports.

Turn the plate forward or backward.

Once reached the correct inclination, tighten the bolt **A** on the lock side.

Check the footplate engages and disengages easily (you may need to make a minor angle adjustment working on the plate) and then tighten the bolt **A** of the rotation side.

With elliptical tube: tighten the grab screw **A1**.

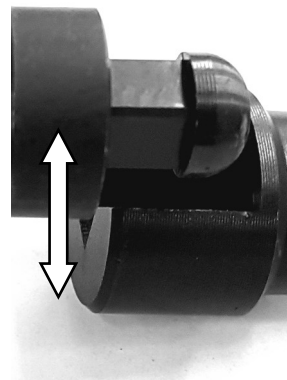

POSITIONING

4 positions: internal; 2/3 internal; 2/3 externa; external

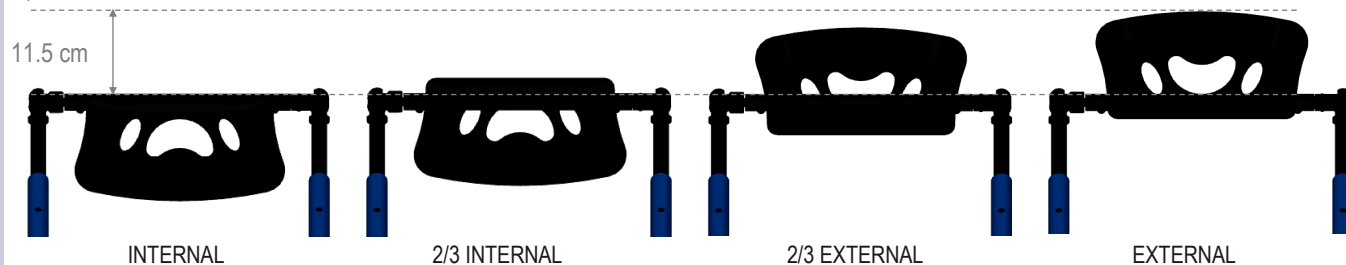

CHANGING THE PLATE POSITION

Remove the 4 bolts **B** and fix the plate using the other set of holes.

The plate can be orientated with its curved side facing either back or front.



Follows next page



ONE PIECE FLIP-UP ALUMINUM FOOTPLATE FOR JOKER "ZERO"

SERVICE MANUAL

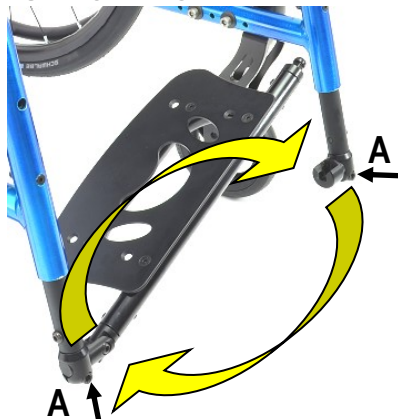

REVERSING THE FOOTPLATE

- 1) Loosen the angle adjustment bolts **A** and slide off the lock and rotation sides supports from the tube and assemble them reversing their position.
- 2) Or, remove the tubes, follow instructions of chapter *footplate distance* and assemble them reversing their side.

Finally, adjust the inclination and tighten the bolts **A**— see also "*angle adjustment*". Using either of these two methods, you can turn the footplate position from internal to external (or vice versa) or from 2/3 internal to 2/3 external (or vice versa). When reversing the footplate in either these two methods, you change the lock side, too.

CHANGING THE LOCK SIDE WHILE KEEPING THE SAME PLATE POSITION

Reverse the footplate position as above indicated on point 1 of the chapter "*reversing the footplate*".

The footplate tubular is fixed to the rotation support and to the lock support with two bolts **C** each.

Lift the footplate.

Remove the two bolts **C** of the lock support and slide it off the footplate tubular.

Remove the two bolts **C** of the rotation support and slide the footplate out of it

Should the bolts be too hard to unscrew, you will have to heat them up in order to make the thread lock glue lose its efficiency.

Spread some mild or strong thread lock glue on the bolts **C**.

Insert the lock and rotation supports on the footplate tubular opposite and fix them with the bolts **C**.

Pay attention when fixing the rotation support, in fact, it can rotate on one direction only (if it is mounted opposite, the footplate can only rotate downward).

Adjust the inclination and tighten the bolts **A**— see also "*angle adjustment*".

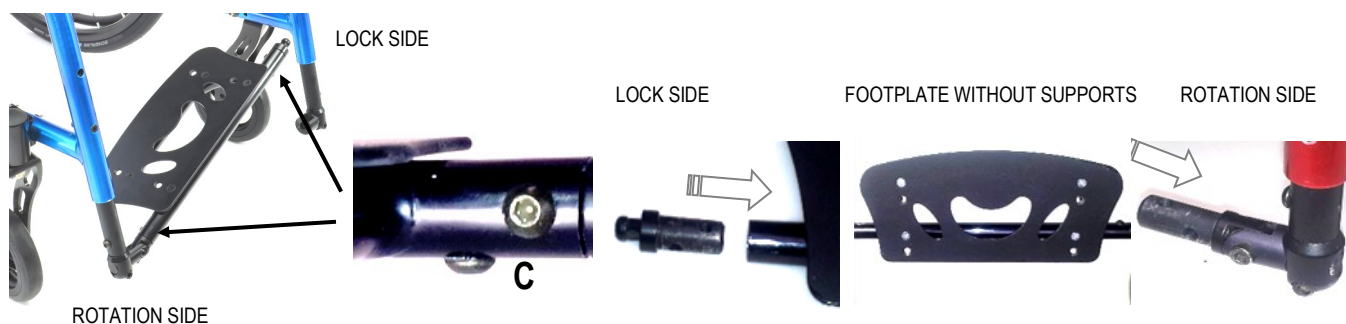

FRICIONING THE ROTATION

To adjust the friction of the footplate rotation movement, tighten or loosen the bolt **D**.

It is advisable to remove the bolt, squeeze a little part of its thread with a long nose pliers, spread a drop of strong thread lock glue, insert it and screw it. In fact, the movement of the footplate can lead that bolt to unscrew itself. Usually, when the footplate is lifted up the adjustment holds it in place.

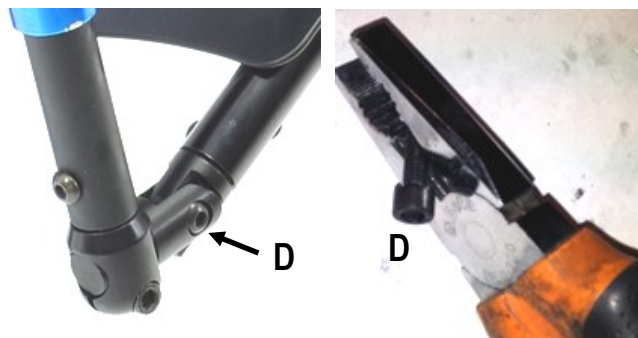



ONE PIECE FLIP-UP CARBON FOOTPLATE FOR JOKER "ZERO"

SERVICE MANUAL

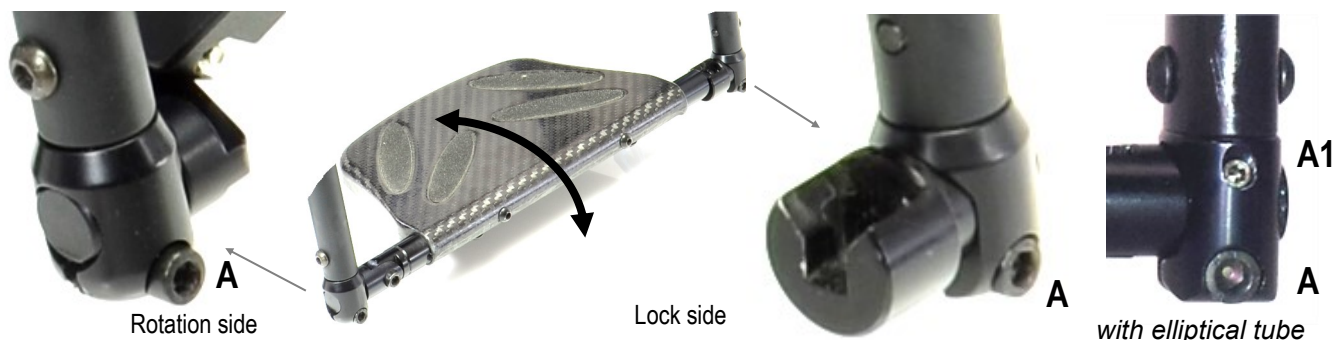

ANGLE ADJUSTMENT

Leave the footplate engaged in the using position.

With round tube: loosen the bolt **A** of both adjustment supports.

With elliptical tube: loosen the grab screw **A1** and the bolt **A** of both adjustment supports.

Turn the plate forward or backward.

Once reached the correct inclination, tighten the bolt **A** on the lock side.

Check the footplate engages and disengages easily (you may need to make a minor angle adjustment working on the plate) and then tighten the bolt **A** of the rotation side.

With elliptical tube: tighten the grab screw **A1** of both supports.

Note: this kind of footplate allows for the plate to be turned 180°, therefore, before proceeding with the adjustment, raise the plate from the lock side and turn it until its rotation stops.

This rotation allows for a temporary opposite position of the plate, but it also helps to reduce the encumbrance if the plate, in its normal use, is positioned "external".

To carry out such operation, just raise the plate from the lock support and turn it to the opposite position; then engage it to the lock support normally.

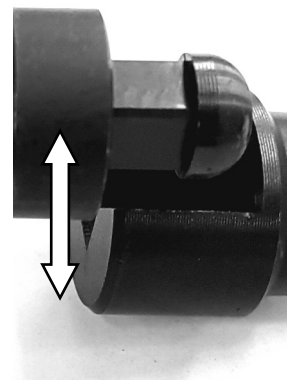

POSITIONING

2 positions: internal; external

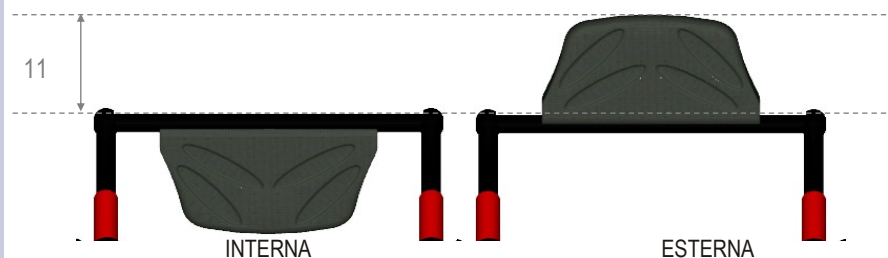

REVERSING THE FOOTPLATE

1) Loosen the angle adjustment bolts **A** and slide off the lock and rotation sides supports from the tube and assemble them reversing their position.

2) Or, remove the tubes, follow instructions of chapter *footplate distance* and assemble them reversing their side.

Finally, adjust the inclination and tighten the bolts **A**— see also "angle adjustment".

When reversing the footplate in either these two methods, you change the lock side, too.

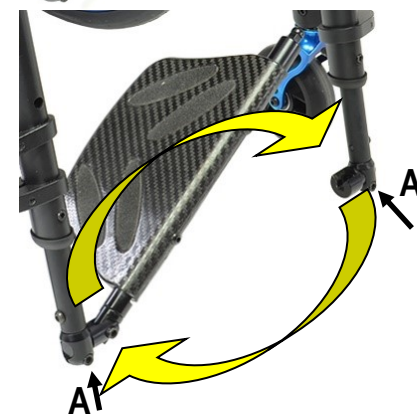

Follows next page



ONE PIECE FLIP-UP CARBON FOOTPLATE FOR JOKER "ZERO"

SERVICE MA-

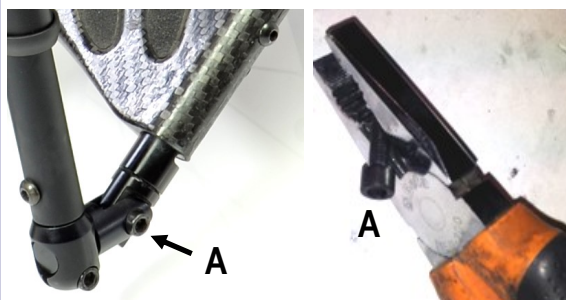
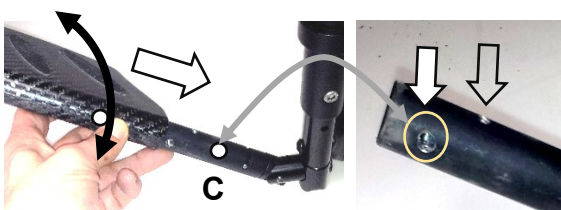
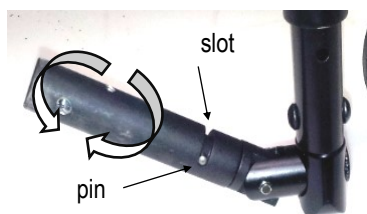
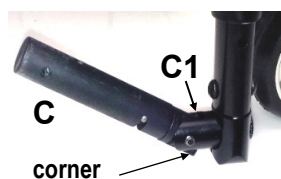
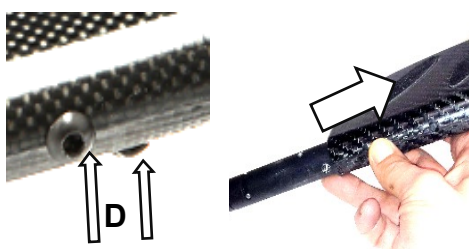
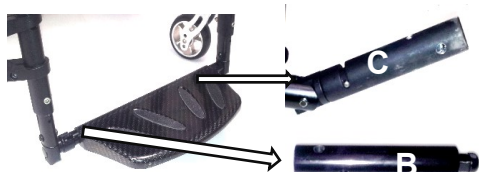
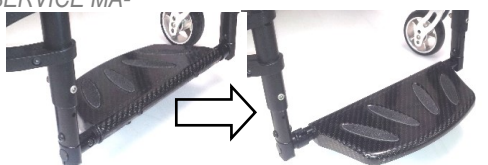

CHANGING THE LOCK SIDE WHILE KEEPING THE SAME PLATE POSITION

Reverse the footplate position as above indicated on point 1 of the chapter "reversing the footplate".

The footplate is fixed with the rotation tube **B** and the lock tube **C** with two bolts **D** each.

Lift the footplate.

Remove the 2 bolts **D** on the lock side **B** and slide the support off the footplate.

Remove the 2 bolts **D** on the rotation side **C** and slide the footplate off.

Should the bolts be too hard to unscrew, you will have to heat them up in order to make the thread lock glue lose its efficiency.

Spread some strong thread lock glue on the bolts **D**.

Insert the lock tube **C** into the other side of the footplate and fix the bolts **D**.

Assemble the rotation tube to the support **C1** so that the rotation of is upward (the corner of the extremity of the tube must be assembled at the bottom).

The tube **C** is made in two parts fixed together by means of a cylindrical pin that also works as full stroke of the 180° rotation along the slot.

The correct fixing of the footplate to the tube **C** has to allow the footplate, after lifting it up, to rotate front and backward moving upward.

Partly insert the footplate onto the tube **C** and align the front hole of the footplate and the external hole of the tube **C**.

Holding the two parts, check that the rotation is upward. If the rotation is downward, hold the footplate and turn only the tube **C** by 180°. Check the rotation again.

Spread some mild or strong thread lock glue on the bolts **D**.

Likewise, insert the footplate along the tube **B** making the hole coincide. Then fix the two bolts **D**.

Adjust the footplate inclination following the instruction of the chapter "angle adjustment".

FRICIONING THE ROTATION

To adjust the friction of the footplate rotation movement, tighten or loosen the bolt **A**.

It is advisable to remove the bolt, squeeze a little part of its thread with a wrench, spread a drop of strong thread lock glue, insert it and screw it. In fact, the movement of the footplate can lead that bolt to unscrew itself. Usually, when the footplate is lifted up the adjustment holds it in place.



SERVICE MANUAL

BACKREST HEIGHT

Aluminium or titanium backrest

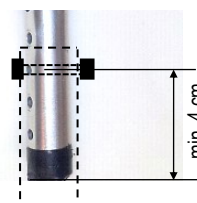

Remove the backrest upholstery and slide up the protecting sleeves of the backrest bands along the tube until the fixing screws are visible.

If the bolt is not accessible, remove the mudguard if it is removable or tilt the backrest backward by means of its adjustment system (see backrest angle adjustment sheet).

Remove bolt and nut **A** and raise or lower the backrest tubes to the desired height.

If the minimum height you can reach is not enough, it is necessary to cut the lower side of the.

If the maximum height you can reach is not enough, it is necessary to change the tube.

Warning: to guarantee a good stability, between the fixing hole and the lower side of the tube, there should be at least 4 cm. If the tube is cut, the lower hole will be only a few millimetres from the end of the tube; therefore, you should not use that hole, the next and, sometimes even the third to fix the backrest height.

Replace the screws and tighten.

To reduce possible play and possible noise, you can put some sticky tape around the inner tube at its bottom and at its fixing point (or just under it).

Note: if the backrest tube is in carbon fibre, follow the instructions of the adjustment sheet "*backrest height—carbon fibre backrest*".

The titanium backrest structure includes a plastic adaptor, just follow the same instructions above.





SERVICE MANUAL

BACKREST HEIGHT

Carbon fibre backrest

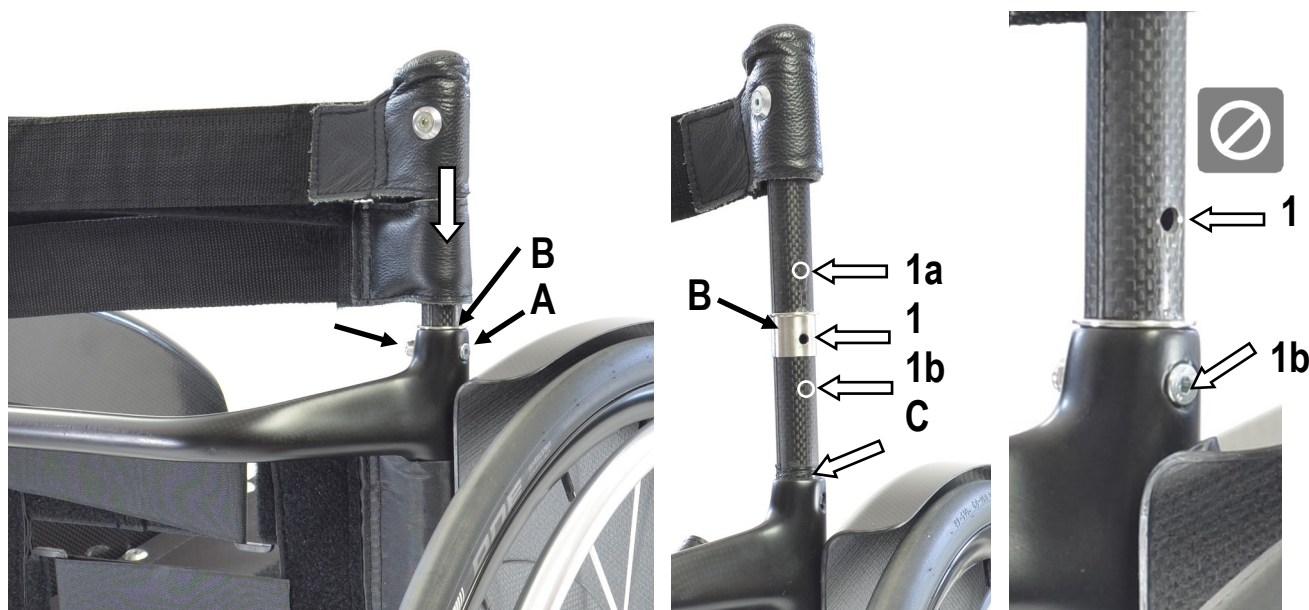

Remove the backrest upholstery and slide up the protecting sleeves of the backrest bands along the tube until the fixing screws **A** are visible.

In the fixing point, you will also see a steel buckle **B**.

If the bolt is not accessible, remove the mudguard if it is removable or tilt the backrest backward by means of its adjustment system (see backrest angle adjustment sheet).

Remove bolt and nut **A**.

The backrest tubes have only one hole that is originally drilled according to the height requested in the order form.

On the pictures above, you can see that the fixing point is the **1**.

The point **1a** could be a new hole to lower the backrest height and that is possible without creating problem (you may need to cut off the bottom side of the tube), in fact, the hole **1** will be underneath and within the tube of the backrest structure. While drilling the hole on the tube, pay attention to aligning the handle grip (if present).

Should you cut off the bottom side the tube, insert the buckle **B** on the tube and put a few turns of sticky tape **C** around the extremity of the tube to reduce a possible play.

Insert bolt and nut **A** and tighten **without overtightening** to avoid damaging the carbon fibre.



The **1b**, on the other hand, would be the point where to drill a new hole to increase the backrest height, but, by doing so, the hole **1** would be out of the backrest structure and it would create a situation of possible breakage of the tube during normal use of the wheelchair. This operation is not allowed.

Warning: to guarantee a good stability, between the fixing hole and the lower side of the tube, there should be at least 4 cm.



The carbon fibre backrest tube is not suitable to fixing any clamps, such as those used for a postural system hardware.

Note: if the backrest tube is assembled on a aluminium or titanium backrest structure, follows these same instructions.



SERVICE MANUAL

BACKREST ANGLE

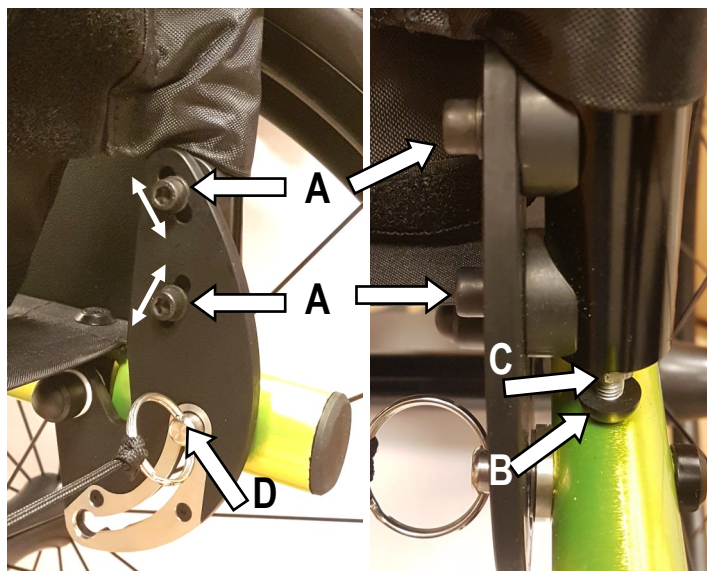

Adjustment from 16° close, tilted forward (74°) to 4° open, tilted backward (94°) with respect to 90° to the seat.

If you need to open (tilt backward) the angle, before proceeding, with the adjustment, fold the backrest, loosen the nut **C** and screw the bolt **B** that determine the end run, that is the point where it will lean on the frame. Such operations are not necessary when you need to close (tilt forward) the angle.

The adjustment can be performed thanks to the two bolts **A** sliding along the slots through which they pass and fix the backrest tube.

Therefore, loosen the two bolts **A** on both backrest plates, tilt the backrest to the desired inclination and securely tighten the bolts.

Now check the locking system.

If the locking pin **D** does not lock, or there is too much play, it is necessary to adjust the end run bolt **B**.

Loosen the nut **C**, fold the backrest and screw or unscrew the bolt **B**.

Open the backrest and check if it locks and its play.

To check the play, with the locked backrest, gently pull back it and forth.

If the play is still a lot, loosen the bolt **B**, whereas, if the backrest does not lock, screw the bolt **B**.

The correct adjustment is when the pin locks and the play is minimum. Then screw the nut **C** towards the tube.

Not only does the end run bolt **B** reduce the backrest play, but also it is very important as point of support of the backrest. In fact if it is badly adjusted (a lot of play) the lock pin **D** will support all the backrest stress and it may be damaged or even brake.

Remember that the backrest angle can affect the point of balance of the wheelchair. In fact, with tilted backward backrest (open angle), the wheelchair becomes less stable.



QUICK RELEASE AXLE

(rear wheel)

SERVICE MANUAL

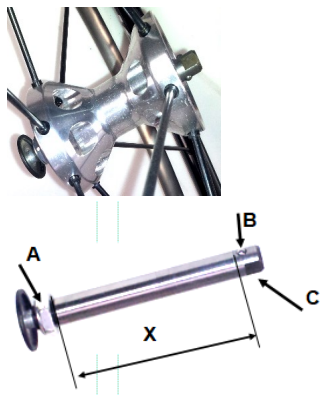

Adjust the quick release axle so that the rear wheel is safely fixed with no risk that it comes off accidentally.

At the same time, there should be no or very little play.

To check if the rear wheel is safely fixed, take hold of the hub without pressing the release button, and try to pull the wheel in and out.

As regular maintenance, it is advisable to clean the quick release axle and spread a little of grease on it.

If the wheel comes off, the distance **X** between the nut **A** and the balls **B** is too short, therefore, it is necessary to unscrew the nut **A** while holding the point **C** of the axle. **If there is play**, the distance **X** between the nut **A** and the balls **B** is too long, therefore, it is necessary to screw the nut **A** while holding the point **C** of the axle

In both cases, make a few tries until the correct adjustment. There is no need to remove the axle from the wheel.



It may happen that you adjust the axle so that the wheel only seems properly fixed, but it is not safe.

In fact, to check the adjustment, you have also to try to press the button just a little bit (as guidance, 1/4 of its run) and pull the wheel. If it comes off, it means that it may come off while driving! Therefore, this is a very important **safety check**.

If the wheels comes off, unscrew the nut a little bit until you have the proper adjustment.

If the wheel (the axle) gets stuck in the receiver, you can proceed in two ways:

Press the quick release button, pull the rear wheel and, at the same time, with a mallet, gently hit (a little harder if necessary) the hub or spokes of the wheel and try to remove it.

Loosen the grab screw **A** and try to remove the wheel.

Loosen the two bolts **B** (aluminium plate) or the two bolts **B** and the bolt/nut **C** (Full Carbon plate) and try to remove the wheel.

If you have loosened both the grab screw **A**, the bolts **B** and the bolt/nut **C** (only Full Carbon plate), fix the bolts **B** first, then the grab screw **A** and finally the bolt/nut **C** (see also sheet "camber and convergency").

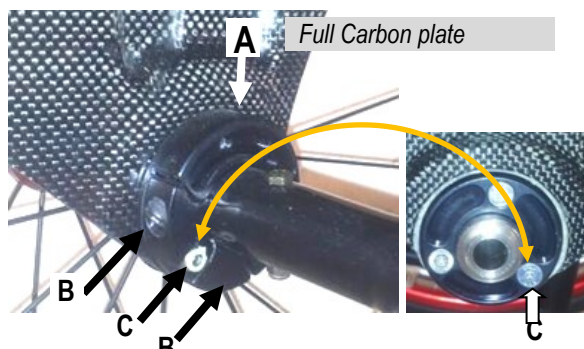
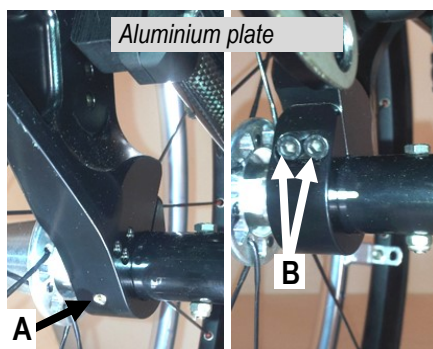

The reasons why the wheel can get stuck can be two.

- the receiver is slightly damaged; in this case, with a 1/2 reamer, re-pass the receiver's hole.
- when pushing the axle's button, the balls do not fall inside the axle's shaft; first, clean the axle, then try to push the button a few times a see if you have solved the problem; if not, press the button, hold the axle's pin with a wrench and unscrew the button half of a turn. Check and if necessary do the same with another half turn. Do not unscrew the button too much: the pin will come off and, consequently, the balls will fall to the ground.

